

# CATÁLOGO DE PRODUCTOS

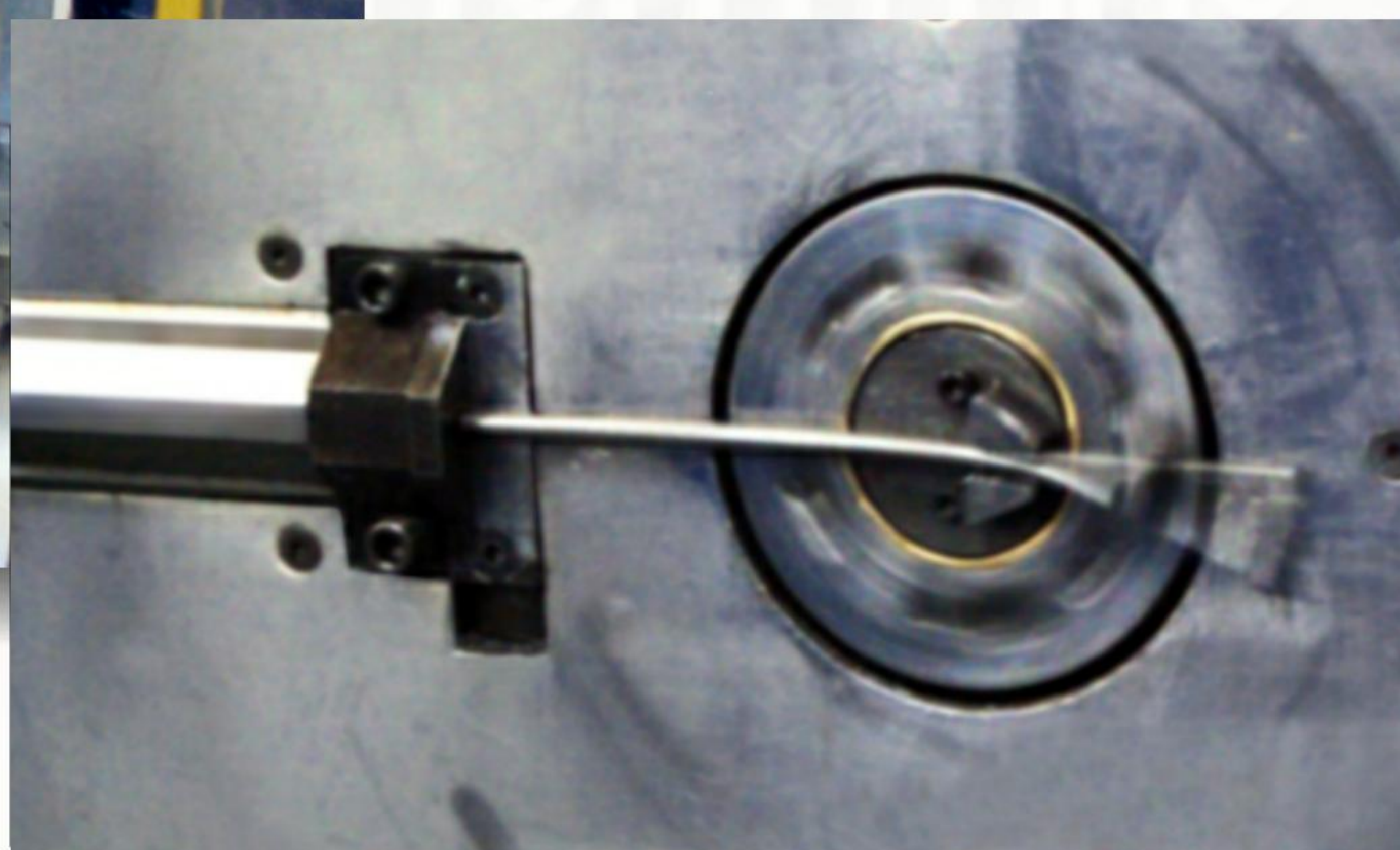

2017

# A Rod-Car



## Tecnologia

Investimos constantemente em novas tecnologias e equipamentos a fim de otimizar cada vez mais nossas linhas de produção. Melhorias constantes em nossos produtos garantem a qualidade que somente a marca Rod-Car oferece aos seus clientes.

Dispositivos automatizados e modernos maquinários de corte, dobra, solda e injeção plástica de última geração compõem nosso parque fabril, atendendo a uma grande demanda interna e aos diversos segmentos de mercado.



## Diferencial

Nossa matéria-prima segue um rígido controle de qualidade junto aos nossos fornecedores. Isso eleva a qualidade do produto final, proporcionando maior durabilidade e assegurando sempre o melhor custo-benefício.

Contamos ainda com ferramentaria própria, o que nos permite melhorias constantes em nossos processos de injeção, estamparia e no produto final.



## Missão

Ser a principal empresa a desenvolver soluções para movimentação e armazenagem de materiais, primando pela qualidade de seus produtos e facilitando a vida em sociedade.



## Visão

Ser a empresa sinônimo na solução para os problemas recorrentes em movimentação e armazenagem de materiais.



## Valores

- Ética em seus negócios;
- Transparência com seus parceiros comerciais e colaboradores;
- Excelência na qualidade de seus produtos e serviços;
- Respeito ao meio ambiente.



*Só quem é líder carrega esta marca*

# Nossa História



**F**undada em 1º de junho de 1966, a Rod-Car é hoje uma das principais empresas de movimentação e armazenagem de materiais do País.

Com origem na fabricação de Rodas e Rodízios e também os então chamados Carros Industriais, na metade da década de 60, a empresa começou suas atividades em um modesto armazém no Bairro do Brás em São Paulo.



A Rod-Car não parou por aí, buscou novos desafios e mercados. A empresa começou a produzir equipamentos para a Hotelaria internacional, que chegou ao país no início da década de 70, como a rede Hilton, por exemplo. Sempre atenta às novas oportunidades de mercado, na década de 70 surgiu uma grande oportunidade na fabricação de Carrinhos para Supermercados. Com a expertise na fabricação de rodízios e diversos tipos de carrinhos, logo, esta nova divisão conquistou a liderança no setor supermercadista.

O país já pensava em modernizar suas indústrias e, nos anos 80, a necessidade de estocagem de materiais e melhoria no fluxo de produção pedia um novo produto, os Containers Aramados desmontáveis e empilháveis. A empresa já dominava a manufatura de produtos em arame e uma nova divisão surgia, a de Armazenagem e logística. Para completar suas linhas, a Rod-Car foi grande importadora de produtos das marcas Rubbermaid e Metro para o Brasil e Mercosul.

Sua mais nova divisão é a de Prateleiras Aramadas, um moderno sistema de quatro postes, onde se pode compor quantas prateleiras necessitar.

Localizada hoje no Parque Industrial de Cumbica em Guarulhos / SP, e com uma área de 30.000m<sup>2</sup>, a empresa conta com um maquinário de ponta para atender todas as suas necessidades de produção. Uma empresa com seis divisões distintas de produtos e com diversos mercados de atuação.

# RODAS E RODÍZIOS

Ruedas // Carstors and wheels



**Linha Leve (Institucional)**

Ideais para aplicações de grandes cargas com pequenos rodízios, como em freezer vertical ou horizontal e esteiras mecânicas.



**Móveis**

**Linha Leve (industrial)**

Desenvolvida para aplicações de cargas moderadas e de tração manual.



**Inox**

**Linha Intermediária Reforçada**

Desenvolvida para aplicações de cargas que vão de moderadas a intermediária e de tração manual.



**Linha Média Reforçada**

Projetados para suportar a movimentação de equipamentos de porte médio com tração manual em pisos de boa conservação sem obstáculos.



**Andaimes**

**Linha Pesada Axial**

Produzidos para suportar cargas pesadas, são ideais para a movimentação de equipamentos nos diversos tipos de pisos industriais.



**Temperaturas Elevadas**

**Duplo pesado Axial Extra**

Produzidos para suportar cargas pesadas, são ideais para a movimentação de equipamentos nos diversos tipos de pisos industriais.



**Linha Pneumática**

Disponíveis nas versões com câmara e rodas de pneu maciço, ultrapassa obstáculos com facilidade e mantém uma boa conservação do piso.



**Impactos**

**Freios e Acessórios**



Freio ON

Freio OA

Freio Pedal

Guarda Corpo

Trava Direcional

**SOLICITE NOSSO CATÁLOGO COMPLETO DA DIVISÃO DE RODAS E RODÍZIOS!**

# HOTELARIA

Hospitalidad // Hospitality



# Carros Portaria P1

Carros de recepção // Luggage carts



P1 FLP Latão  
Linha Full



P1 SLP Latão  
Linha Simplex



P1 FXP Inox  
Linha Full



P1 SEB E-Zink  
Linha Simplex

	MODELO	MEDIDAS	MATERIAL	CARPETE	RODA	DIÂMETRO
FULL	P1 FLP	Cx L x A 98 x 59 x 119 cm	LATÃO	VINHO	PNEU	10" 250 mm
	P1 FLB		LATÃO	VINHO	BORRACHA	
	P1 FXP		INOX	GRAFITE	PNEU	
	P1 FXB		INOX	GRAFITE	BORRACHA	
	P1 FEP		E-ZINK	GRAFITE	PNEU	
	P1 FEB		E-ZINK	GRAFITE	BORRACHA	
SIMPLEX	P1 SLP	Cx L x A 98 x 59 x 119 cm	LATÃO	-	PNEU	10" 250 mm
	P1 SLB		LATÃO	-	BORRACHA	
	P1 SXP		INOX	-	PNEU	
	P1 SXB		INOX	-	BORRACHA	
	P1 SEP		E-ZINK	-	PNEU	
	P1 SEB		E-ZINK	-	BORRACHA	

# Carros Portaria P2

Carros de recepção // Luggage carts bird cage

## Gaiolas



P2 SLP Latão



P2 SLB Latão



P2 SXB Inox



P2 SXP Inox

A Rod-Car é Pioneira na fabricação de produtos para hotéis no Brasil. Nossos carros são produzidos no Padrão Internacional, com estrutura reforçada e acabamentos anti-ferrugem.

	MODELO	MEDIDAS	DESCRIÇÃO	CARPETE	RODA	DIÂMETRO
STANDARD	P2 SLP	C x L x A 114,5 x 66 x 194cm	LATÃO	VINHO	PNEU	8" 200 mm
	P2 SLB		LATÃO	VINHO	BORRACHA	
	P2 SXP		INOX	GRAFITE	PNEU	
	P2 SXB		INOX	GRAFITE	BORRACHA	

## Linha Transformer



P3 GLP Latão



P3 PLB Latão



P3 GXP Inox



P3 PXB Inox

	MODELO	MEDIDAS	DESCRIÇÃO	CARPETE	RODA	DIÂMETRO
GRANDE	P3 GLP	CxLxA 114 x 66 x 192 cm	LATÃO	VINHO	PNEU	8" 200 mm
	P3 GLB		LATÃO	VINHO	BORRACHA	
	P3 GXP		INOX	GRAFITE	PNEU	
	P3 GXB		INOX	GRAFITE	BORRACHA	
	P3 GEP		E-ZINK	GRAFITE	PNEU	
	P3 GEB		E-ZINK	GRAFITE	BORRACHA	
PEQUENO	P3 PLB	CxLxA 94 x 48 x 185,5 cm	LATÃO	VINHO	BORRACHA	6" 150 mm
	P3 PXB		INOX	GRAFITE	BORRACHA	
	P3 PEB		E-ZINK	GRAFITE	BORRACHA	

## Carros Portaria P4

Carros de recepción // Luggage carts self service



P4-AVGF

P4-AVP

P4-MÉDIO

P4-HE

MODELO	MEDIDAS	ACABAMENTO	RODA
P4-HG	88 x 62 x 103,5cm	HIGH GLOSS	BORRACHA
P4-HE		E-ZINK	BORRACHA
P4-Z		ZINCO	BORRACHA
P4 AVGF	109 x 60,3 x 102cm	E-ZINK	BORRACHA
P4 AVG		E-ZINK	BORRACHA
P4 AVPF		E-ZINK	BORRACHA
P4 AVP	66,5 x 56 x 99,5cm	E-ZINK	BORRACHA
P4 MÉDIO	101,5 x 65,3 x 107cm	E-ZINK	BORRACHA

## Carros Portaria P5

Carros de recepción // Luggage carts



P5-CP Cromado  
com pneu

P5-PB Pintado  
com roda de Borracha

MODELO	MEDIDAS	DESCRIÇÃO	RODA
P5 CP	CxLxA 121 x 66 x 103 cm	CROMO	PNEU
P5 CB		CROMO	BORRACHA
P5 PP		PINTADO	PNEU
P5 PB		PINTADO	BORRACHA



## Linha Classic

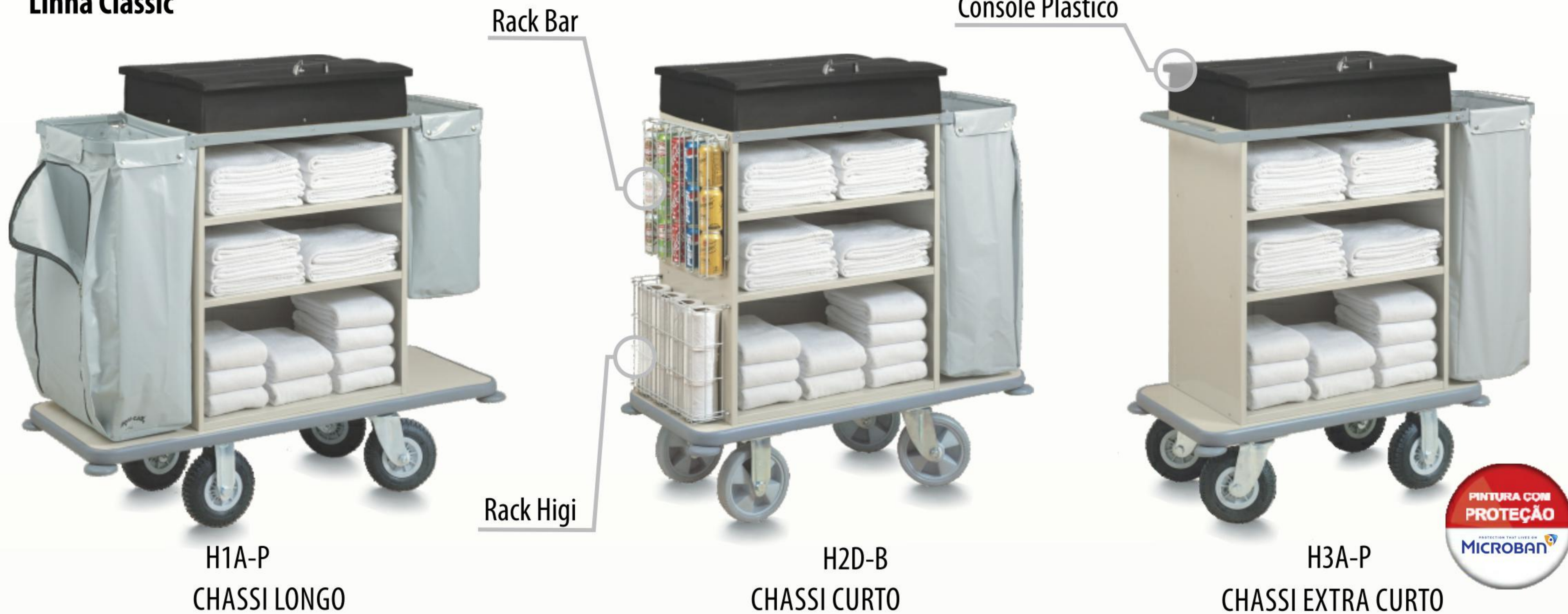

H1A-P  
CHASSI LONGO

H2D-B  
CHASSI CURTO

H3A-P  
CHASSI EXTRA CURTO



	REFERÊNCIA		MODELO	MEDIDAS	SACOS (LITRO)				
	CLASSIC	ECONO			QNT.	MINI	PEQ.	GRD.	EXT. GRD.
LONGO	H1A	EH1A	BÁSICO	CxLxA* 137 x 52 x 131cm	2	-	70	-	175
	H1B	EH1B	BAR-LUX		1	-	-	-	175
	H1C	EH1C	PRAT-LUX		1	-	-	-	175
	H1H	EH1H	DUPLO SACO GDE		2	-	-	110	-
CURTO	H2A	EH2A	BÁSICO	CxLxA* 117 x 52 x 131cm	1	-	-	-	175
	H2B	EH2B	2 RACK BAR		1	-	-	-	175
	H2C	EH2C	2 RACK HIGI		1	-	-	-	175
	H2D	EH2D	1 RACK BAR 1 RACK HIGI		1	-	-	-	175
	H2E	EH2E	DUPLO SACO		2	20	-	-	175
	H2H	EH2H	DUPLO SACO GDE		2	-	-	110	-
EXTRA CURTO	H3A	EH3A	BÁSICO	CxLxA* 96 x 52 x 131cm	1	-	-	110	-
	H3B	EH3B	2 RACK BAR		1	-	-	110	-
	H3C	EH3C	2 RACK HIGI		1	-	-	110	-
	H3D	EH3D	1 RACK BAR 1 RACK HIGI		1	-	-	110	-
	H3E	EH3E	1 MINI LIXO 1 RACK BAR		2	20	-	110	-
	H3F	EH3F	1 MINI LIXO 1 RACK HIGI		2	20	-	110	-
	H3H	EH3H	DUPLO SACO GDE		2	-	-	110	-

\* As medidas da tabela acima, refere-se ao produto da linha Classic, para a linha Econo com roda de borracha considere a altura de 110cm, para a linha Econo com roda pneumática considere a altura de 116cm

## Linha Econo



Todos os modelos com opções de rodas pneumáticas e portas.



CLASSIC



H1HPC-B

ECONO



EH1HPC-P

LONGO	REFERÊNCIA		MODELO	MEDIDAS C x L x A		SACO (LITRO)		DIÂMETRO	RODA
	CLASSIC	ECONO		CLASSIC	ECONO	QNT.	TAMANHO		
		H1HPC	EH1HPC	BÁSICO	152 x 60 x 134cm	152 x 60 x 120cm	2	105	6"
	H1HPC-B	EH1HPC-B	BÁSICO	152 x 60 x 141cm	152 x 60 x 127cm	2	105	8"	BORRACHA
	H1HPC-P	EH1HPC-P	BÁSICO			2	105	8"	PNEU

## Carros Arrumadeira Toalheiro

Carros de Camarera Toallero // Extra towel housekeeping cart



H1T-B



EH1T-P

LONGO	REFERÊNCIA		MODELO	MEDIDAS C x L x A*	SACOS (LITRO)				
	CLASSIC	ECONO			QNT.	MINI	PEQ.	GRD.	EXT. GRD.
		H1T	EH1T	TOALHEIRO	137 x 52 x 131cm	1	-	-	-

\* As medidas da tabela acima, refere-se ao produto da linha Classic, para a linha Econo com roda de borracha considere a altura de 110cm, para a linha Econo com roda pneumática considere a altura de 116cm

## Carros de abastecimento

Carros para frigobar // Restock carts



Frigo Luxo



FL-PO  
117 x 52 x 116cm

Frigo Compact



FC-PO  
96 x 52 x 116cm

Frigolatas



FGT  
74 x 59 x 123cm

Mini Frigolatas



FGTM  
61 x 36 x 103cm

# Carros Arrumadeira Mini

Carros de camarera Mini // Mini housekeeping carts



EHMD-B MINI ARRUMADEIRA

REFERÊNCIA	MODELO	MEDIDAS	SACO (LITRO)		DIÂMETRO	RODA
			QNT.	TAMANHO		
EHMD-B	BASICO	C x L x A	1	50	3"	BORRACHA
EHMDC-B	1 RACK HIGI	93,5 x 38,5 x 101cm	1	50	3"	BORRACHA

# Porta Malas

Suporte para malas // Luggage racks



MODELO	MEDIDAS	MATERIAL	OBS.
Q1-C	C x L x A 63 x 52 x 68 cm	CROMO	STANDARD COM ENCOSTO
Q1-X		INOX	
Q1-H		HIGH GLOSS	
Q1-E		E-ZINK	
Q2-C	C x L x A 63 x 57 x 48,5 cm	CROMO	STANDARD SEM ENCOSTO
Q2-X		INOX	
Q2-H		HIGH GLOSS	
Q2-E		E-ZINK	
Q2J-C	C x L x A 77 x 55 x 50 cm	CROMO	JUMBO SEM ENCOSTO
Q2J-X		INOX	
Q2J-H		HIGH GLOSS	
Q2J-E		E-ZINK	

# Cabides

Perchas // Hangers



Cabide anti-furto com ou sem presilha  
(ganchos e presilhas vendidos para reposição)



# Cama Extra

Cama adicional // Extra bed

Ocupa pouco espaço de Armazenagem, encaixáveis, não acompanha colchão. Atende qualquer quarto.

Medida: 198,5 x 89 x 67cm

# Lavanderia

Lavandería // Laundry



RV  
Carro para roupas molhadas com lona de vinil reforçada.  
Capacidade de 400L para 100kg de roupas.  
Saco de reposição: SRV  
Medida: 91x66x89cm



RC  
Carro para roupas molhadas  
Medida: 110x78x83cm sem tampa  
capacidade de 360L  
Possui tampa opcional TR-C: 112x80x20,5cm  
Carro e tampa disponíveis na cor branca

# Serviço de Quarto

Servicios de habitación // Room service



\*CBS  
Carro bandeja plástico  
Medida: 106 x 51 x 98,5cm  
Disponível também em 4 e 5 bandejas  
\* Cores disponíveis conforme estoque.  
Sujeito a alterações.



Carro multifuncional cromado em arame  
Medida: 88 x 49 x 88cm



**RH**  
Carro para roupas secas com lona reforçada. Capacidade de 400L para 100kg de roupas.  
Saco de reposição: SHV  
Medida: 91x66x89cm



**RDV/RDL DOBRÁVEL**  
Carro dobrável vertical com estrutura em E-ZINK-COAT (epóxy). Saco em lona (RDL) ou vinil (RDV) capacidade 158L  
Medida: 69x56x102cm  
saco de reposição: SDL (lona) e SDV (vinil)



**RTR**  
Carro para transporte de roupas E-ZINK-COAT (epóxy). Bandejas basculantes.  
Medida: 82x59x184cm



**ARARA**  
Carro para transporte de roupas Barra zincada, com opção em INOX ou E-ZINK-COAT (epóxy). Disponível em ate 4 barras.  
Medida: 158x70x179cm

## Cozinha

Cocina // Kitchen



**RTP 1**  
Capacidade aproximada: 180 pratos  
Medida: 93x59x88cm



**RTP 2**  
Capacidade aproximada: 360 pratos  
Medida: 93x74x88cm



**RBS**  
Trans-bandeja (Inox). 12 bandejas (40x60cm)  
Medida: 66x53x166cm - vão 12cm  
Consultar outras medidas



**CUBACAR**  
Estrutura em inox com cuba plástica 180L para contato com alimentos  
Medida: 100x59x92cm



\*L3 Com pedal  
\*L3 Sem pedal  
Recipiente flexível para lixo  
L3P- Pequeno: 120L  
L3G- Grande: 240L

\* Cores disponíveis conforme estoque. Sujeito a alterações.



Placas de advertência  
L4 - Piso Molhado  
L5 - Banheiro Fechado  
L6 - Em Manutenção



\*L7  
Carro de limpeza funcional  
Medida: 124,5x53,2x103,3cm  
\* Cores disponíveis conforme estoque. Sujeito a alterações.



L8  
Balde espremedor de Mop capacidade: 24L  
Medida: 51,5x36,5x66cm

Consulte nossa linha completa de acessórios para limpeza em [www.rodcar.com.br](http://www.rodcar.com.br)

# PRATELEIRAS ARAMADAS

*Estanterías Alambradas // Wire Shelving*



# Otimizando espaços com beleza e robustez

Fotos Ilustrativas



Somando qualidade de matéria-prima e a tecnologia de manufatura, a Rod-car produz as melhores Prateleiras Aramadas do mercado, aliando qualidade e beleza com praticidade sem igual.

Elegantes e versáteis, possuem inúmeras utilidades para seu comércio, indústria ou residência. São totalmente modulares, de fácil montagem, não necessitam de ferramentas nem experiência prévia.

A linha é composta por uma gama de postes, prateleiras e acessórios de diversos tipos e tamanhos, capazes de se ajustar ao espaço disponível. Com opções de acabamento cromado, zincado, pintado, highgloss e com acabamento especial para câmara fria.



**Retas**  
Planas / Flats



**Inclinadas**  
En grado / Slanted



**Carrinhos**  
Carrito / Carts

Toda a linha é de fabricação própria Rod-Car no Brasil, que garante qualidade inigualável e progresso ao país.

## Complementos



**Rodízios**  
Rodajas / Casters



**Cabideiro**  
P/ Perchas / For Hanger



**Pés com  
regulagem**



## Montagem em " L "

1º - Para montar prateleiras em formato "L", deixar a ponta frontal de junção sem poste;

2º - Unir as prateleiras com duas presilhas em formato "S"

Presilha formato "S"

Prateleiras presas



## Legendas

Leyendas // Legends

Prateleira Retas		Prateleira Inclinada		Poste		Cabideiro	
Ref.	DESCRIÇÃO	Ref.	DESCRIÇÃO	Ref.	DESCRIÇÃO	Ref.	DESCRIÇÃO
C	Cromada	CG	Cromada Grau	PxxC	Poste Cromado	CAXxC	Cabideiro Cromado
Z	Zincada	ZG	Zincada Grau	PxxZ	Poste Zincado	CAXxZ	Cabideiro Zincado
P	Pintada	PG	Pintada Grau	PxxP	Poste Pintado	CAXxP	Cabideiro Pintado
HG	High Gloss	HGG	High Gloss Grau	PxxHG	Poste High Gloss	CAXxHG	Cabideiro High Gloss
F	Câmara Fria	FG	Câmara Fria Grau	PxxF	Poste Câmara Fria	CAXxF	Cabideiro Câm.Fria

Puxador		Presilha 's'		Presilha 's'	
Ref.	DESCRIÇÃO	Ref.	DESCRIÇÃO	Ref.	DESCRIÇÃO
PUxxC	Puxador Cromado	PRSC	Presilha 'S' Cromado	PRWC	Presilha 'W' Cromado
PUxxZ	Puxador Zincado	PRSZ	Presilha 'S' Zincado	PRWZ	Presilha 'W' Zincado
PUxxP	Puxador Pintado	PRSP	Presilha 'S' Pintado	PRWP	Presilha 'W' Pintado
PUxxHG	Puxador High Gloss	PRSHG	Presilha 'S' High Gloss	PRWHG	Presilha 'W' High Gloss
PUxxF	Puxador Câm. Fria	PRSF	Presilha 'S' Câm. Fria	PRWF	Presilha 'W' Câm. Fria

Fotos Ilustrativas



**AUTO-SERVIÇO**  
Auto Servicio // Markets



**INDÚSTRIA**  
Industria // Industry



**PADARIA**  
Panes // Bakeries



**CÂMARA FRIA**  
Câmara Fria // Cold chamber

Fotos Ilustrativas



**COZINHAS**  
Cocinas // Kitchens



**LOJAS**  
Tiendas // Stores

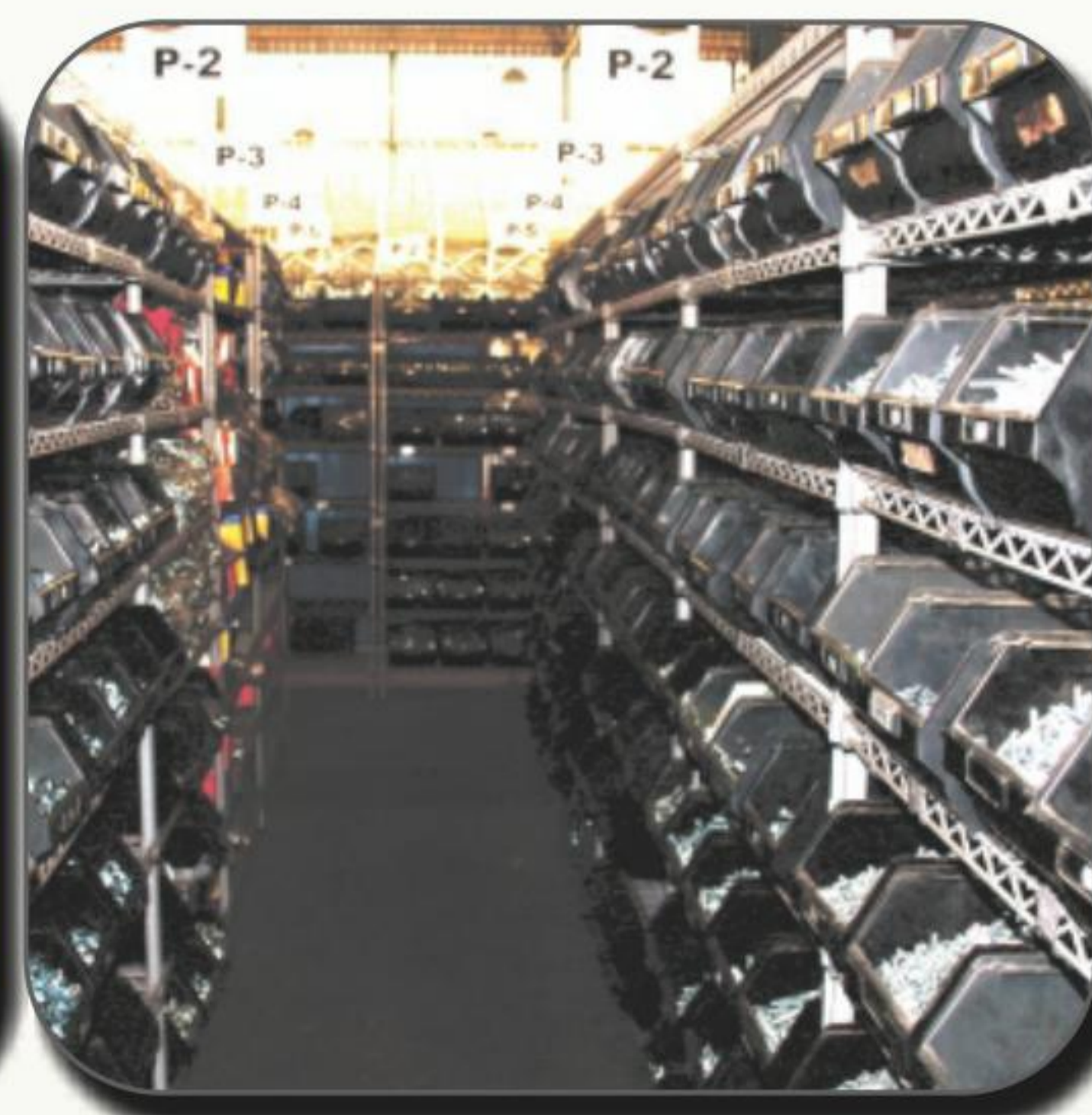

**ALMOXARIFADOS**  
Almacenes // Ware House



**ESCRITÓRIOS**  
Oficinas // Offices



# Prateleiras Reta

Estantes planas // Flat shelving

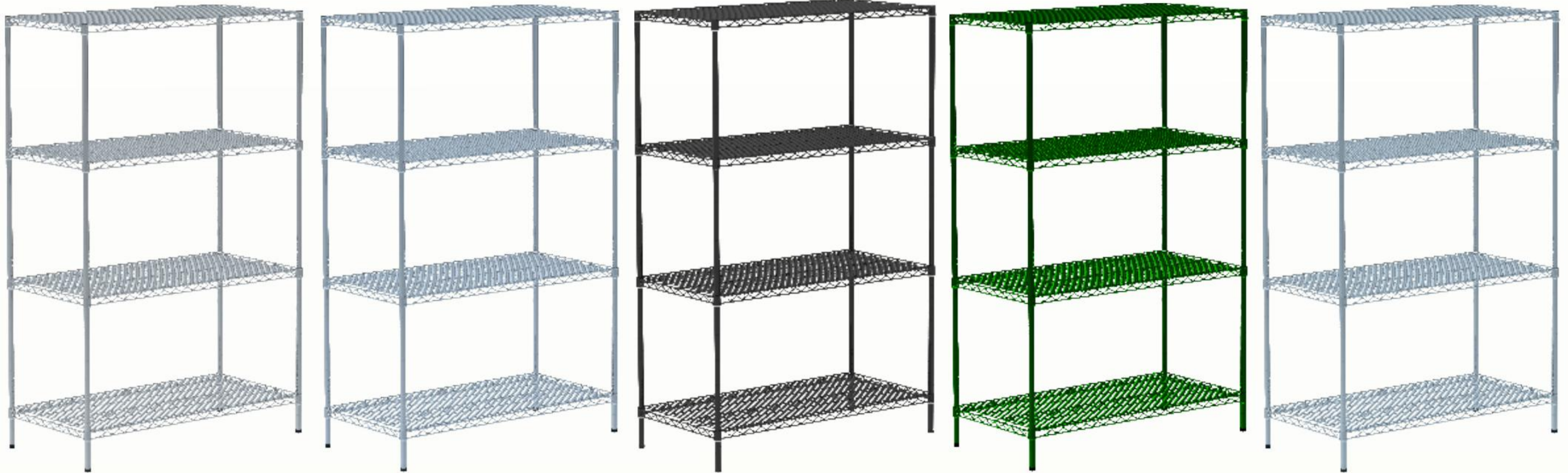

RETA CROMADA	
Ref.	Dimensões
	Centímetro
1418 C	36 x 46
1430 C	36 x 77
1436 C	36 x 92
1442 C	36 x 107
1448 C	36 x 122
1830 C	46 x 77
1836 C	46 x 92
1842 C	46 x 107
1848 C	46 x 122
1854 C	46 x 138
1860 C	46 x 153
2130 C	54 x 77
2136 C	54 x 92
2142 C	54 x 107
2148 C	54 x 122
2160 C	54 x 153
2430 C	61 x 77
2436 C	61 x 92
2442 C	61 x 107
2448 C	61 x 122
2460 C	61 x 153

RETA ZINCADA	
Ref.	Dimensões
	Centímetro
1418 Z	36 x 46
1430 Z	36 x 77
1436 Z	36 x 92
1442 Z	36 x 107
1448 Z	36 x 122
1830 Z	46 x 77
1836 Z	46 x 92
1842 Z	46 x 107
1848 Z	46 x 122
1854 Z	46 x 138
1860 Z	46 x 153
2130 Z	54 x 77
2136 Z	54 x 92
2142 Z	54 x 107
2148 Z	54 x 122
2160 Z	54 x 153
2430 Z	61 x 77
2436 Z	61 x 92
2442 Z	61 x 107
2448 Z	61 x 122
2460 Z	61 x 153

RETA PINTADA	
Ref.	Dimensões
	Centímetro
1418 P	36 x 46
1430 P	36 x 77
1436 P	36 x 92
1442 P	36 x 107
1448 P	36 x 122
1830 P	46 x 77
1836 P	46 x 92
1842 P	46 x 107
1848 P	46 x 122
1854 C	46 x 138
1860 P	46 x 153
2130 P	54 x 77
2136 P	54 x 92
2142 P	54 x 107
2148 P	54 x 122
2160 P	54 x 153
2430 P	61 x 77
2436 P	61 x 92
2442 P	61 x 107
2448 P	61 x 122
2460 P	61 x 153

RETA HIGH GLOSS	
Ref.	Dimensões
	Centímetro
1418 HG	36 x 46
1430 HG	36 x 77
1436 HG	36 x 92
1442 HG	36 x 107
1448 HG	36 x 122
1830 HG	46 x 77
1836 HG	46 x 92
1842 HG	46 x 107
1848 HG	46 x 122
1854 HG	46 x 138
1860 HG	46 x 153
2130 HG	54 x 77
2136 HG	54 x 92
2142 HG	54 x 107
2148 HG	54 x 122
2160 HG	54 x 153
2430 HG	61 x 77
2436 HG	61 x 92
2442 HG	61 x 107
2448 HG	61 x 122
2460 HG	61 x 153

RETA CÂMARA FRIA	
Ref.	Dimensões
	Centímetro
1418 F	36 x 46
1430 F	36 x 77
1436 F	36 x 92
1442 F	36 x 107
1448 F	36 x 122
1830 F	46 x 77
1836 F	46 x 92
1842 F	46 x 107
1848 F	46 x 122
1854 F	46 x 138
1860 F	46 x 153
2130 F	54 x 77
2136 F	54 x 92
2142 F	54 x 107
2148 F	54 x 122
2160 F	54 x 153
2430 F	61 x 77
2436 F	61 x 92
2442 F	61 x 107
2448 F	61 x 122
2460 F	61 x 153

# Postes

Pies // Posts

POSTE CROMADO	
Ref.	Dimensões
	Centímetro
P 32 C	82
P 62 C	158
P 74 C	188
P 80 C	204

POSTE ZINCADO	
Ref.	Dimensões
	Centímetro
P 32 Z	82
P 62 Z	158
P 74 Z	188
P 80 Z	204

POSTE PINTADO	
Ref.	Dimensões
	Centímetro
P 32 P	82
P 62 P	158
P 74 P	188
P 80 P	204

POSTE HIGH GLOSS	
Ref.	Dimensões
	Centímetro
P 32 HG	82
P 62 HG	158
P 74 HG	188
P 80 HG	204

POSTE CÂMARA FRIA	
Ref.	Dimensões
	Centímetro
P 32 F	82
P 62 F	158
P 74 F	188
P 80 F	204

# Opções de cores

Opciones de color // Color options

Pintado epóxi



Pintado High Gloss



**HighGloss**  
Acabamento exclusivo Rod-Car®

Medidas: largura x comprimento (cm)

Medidas: Ancho x Largo // Measurement: width x length (cm)



GRAU 25° CROMADA	
Ref.	Dimensões Centímetro
1430 CG	36 x 77
1436 CG	36 x 92
1442 CG	36 x 107
1448 CG	36 x 122
1830 CG	46 x 77
1836 CG	46 x 92
1842 CG	46 x 107
1848 CG	46 x 122
2130 CG	54 x 77
2136 CG	54 x 92
2142 CG	54 x 107
2148 CG	54 x 122
2430 CG	61 x 77
2436 CG	61 x 92
2442 CG	61 x 107
2448 CG	61 x 122

GRAU 25° ZINCADA	
Ref.	Dimensões Centímetro
1430 ZG	36 x 77
1436 ZG	36 x 92
1442 ZG	36 x 107
1448 ZG	36 x 122
1830 ZG	46 x 77
1836 ZG	46 x 92
1842 ZG	46 x 107
1848 ZG	46 x 122
2130 ZG	54 x 77
2136 ZG	54 x 92
2142 ZG	54 x 107
2148 ZG	54 x 122
2430 ZG	61 x 77
2436 ZG	61 x 92
2442 ZG	61 x 107
2448 ZG	61 x 122

GRAU 25° PINTADA	
Ref.	Dimensões Centímetro
1430 PG	36 x 77
1436 PG	36 x 92
1442 PG	36 x 107
1448 PG	36 x 122
1830 PG	46 x 77
1836 PG	46 x 92
1842 PG	46 x 107
1848 PG	46 x 122
2130 PG	54 x 77
2136 PG	54 x 92
2142 PG	54 x 107
2148 PG	54 x 122
2430 PG	61 x 77
2436 PG	61 x 92
2442 PG	61 x 107
2448 PG	61 x 122

GRAU 25° HIGH GLOSS	
Ref.	Dimensões Centímetro
1430 HGG	36 x 77
1436 HGG	36 x 92
1442 HGG	36 x 107
1448 HGG	36 x 122
1830 HGG	46 x 77
1836 HGG	46 x 92
1842 HGG	46 x 107
1848 HGG	46 x 122
2130 HGG	54 x 77
2136 HGG	54 x 92
2142 HGG	54 x 107
2148 HGG	54 x 122
2430 HGG	61 x 77
2436 HGG	61 x 92
2442 HGG	61 x 107
2448 HGG	61 x 122

GRAU 25° CÂMARA FRIA	
Ref.	Dimensões Centímetro
1430 FG	36 x 77
1436 FG	36 x 92
1442 FG	36 x 107
1448 FG	36 x 122
1830 FG	46 x 77
1836 FG	46 x 92
1842 FG	46 x 107
1848 FG	46 x 122
2130 FG	54 x 77
2136 FG	54 x 92
2142 FG	54 x 107
2148 FG	54 x 122
2430 FG	61 x 77
2436 FG	61 x 92
2442 FG	61 x 107
2448 FG	61 x 122

## Acabamentos

*Acabados // Finishes*

**CROMADO**  
*Cromo // Chrome*

**ZINCADO**  
*Zinc // Galvanized*

**PINTADO**  
*Pintado // Painted*

**HIGH GLOSS**  
*Pintado high gloss // Painting high gloss*

**CÂMARA FRIA**  
*Câmara Fria // Cold chamber*

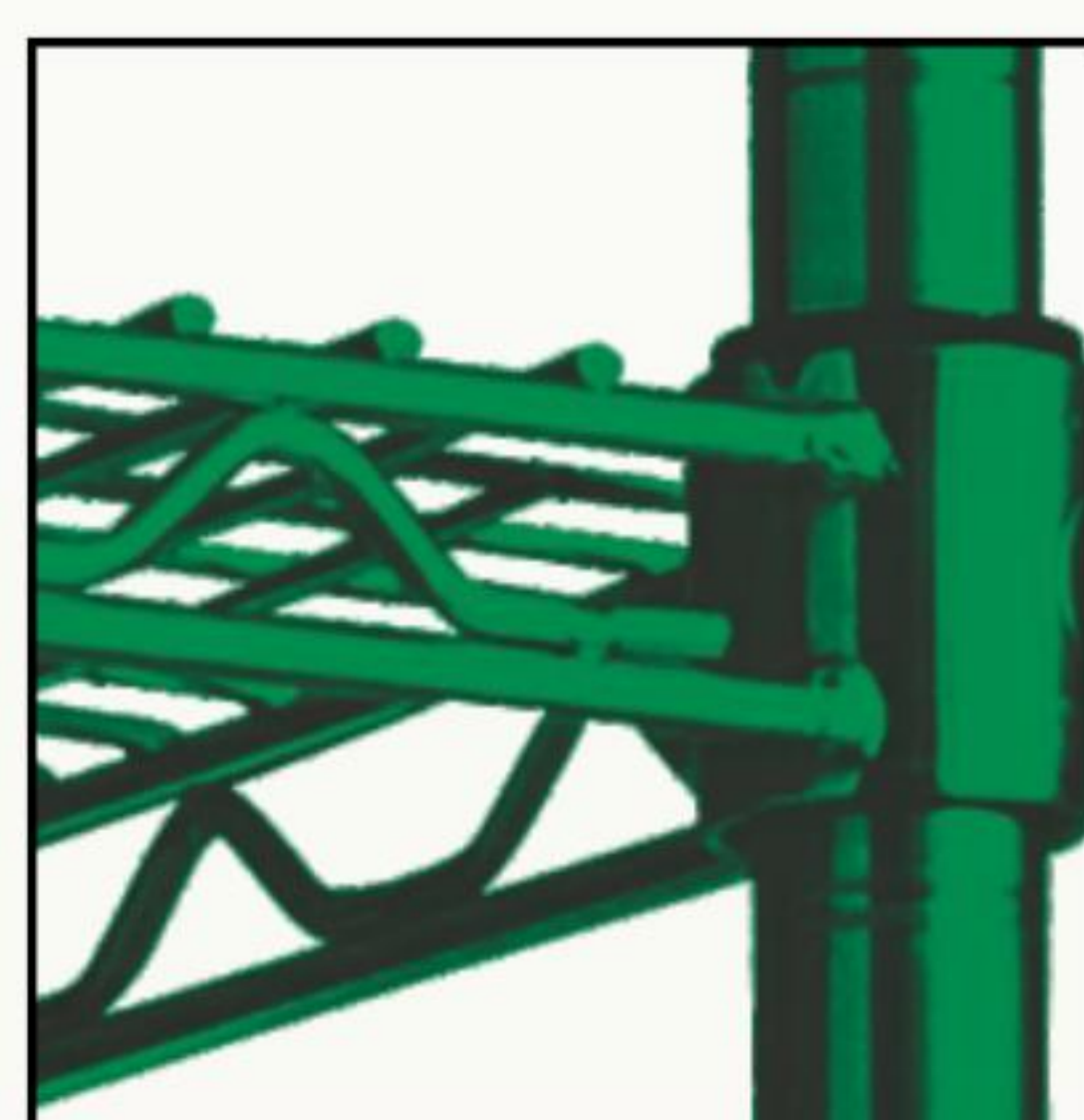
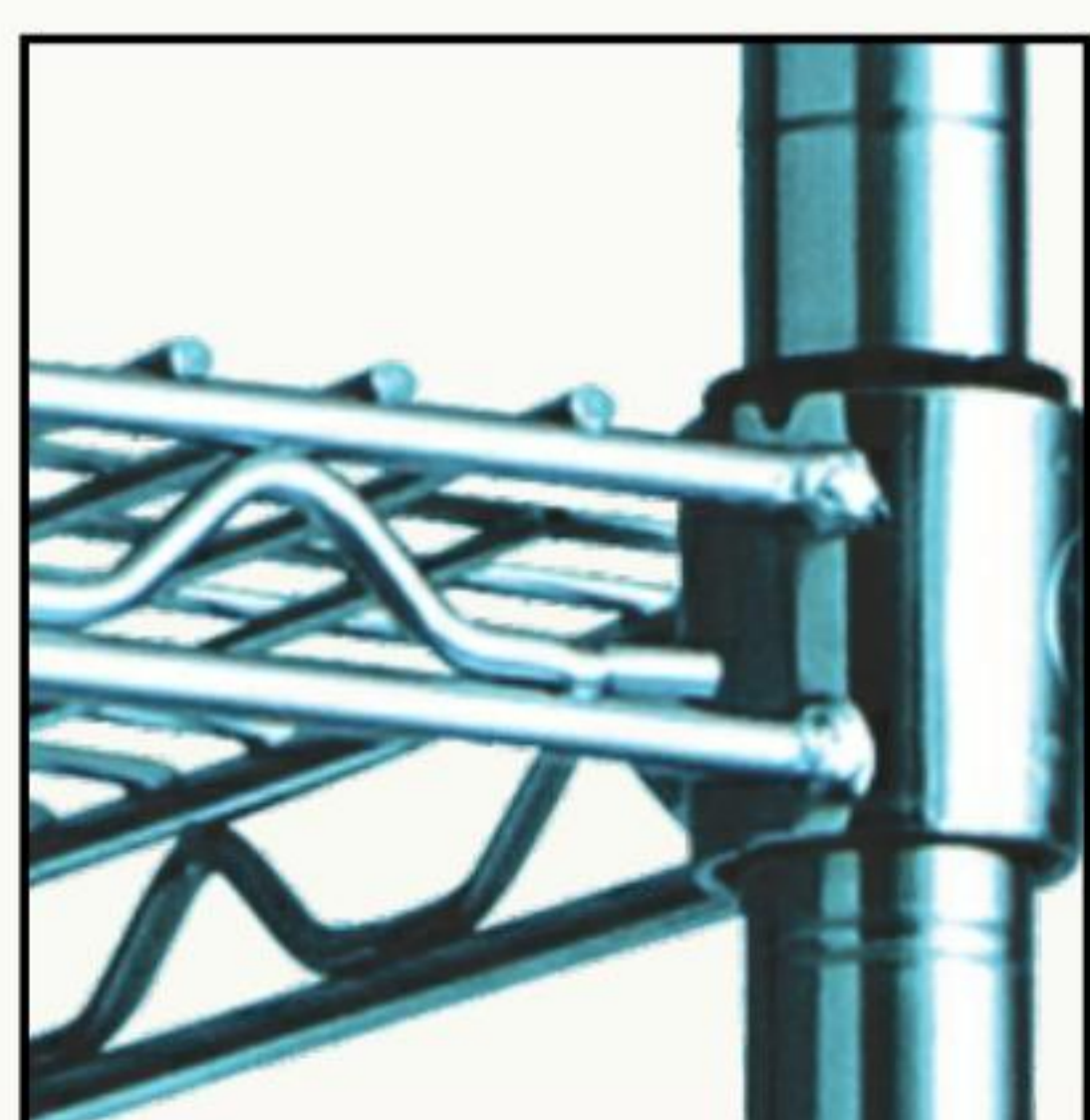

CABIDEIRO CROMADO		CABIDEIRO ZINCADO		CABIDEIRO PINTADO		CABIDEIRO HIGH GLOSS		CABIDEIRO CÂMARA FRIA	
Ref.	Dimensões Centímetro	Ref.	Dimensões Centímetro	Ref.	Dimensões Centímetro	Ref.	Dimensões Centímetro	Ref.	Dimensões Centímetro
CA 30 C	77	CA 30 Z	77	CA 30 P	77	CA 30 HG	77	CA 30 F	77
CA 36 C	92	CA 36 Z	92	CA 36 P	92	CA 36 HG	92	CA 36 F	92
CA 42 C	107	CA 42 Z	107	CA 42 P	107	CA 42 HG	107	CA 42 F	107
CA 48 C	122	CA 48 Z	122	CA 48 P	122	CA 48 HG	122	CA 48 F	122



## Puxadores

Mango // Handle

PUXADOR CROMADO		PUXADOR ZINCADO		PUXADOR PINTADO		PUXADOR HIGH GLOSS		PUXADOR CÂMARA FRIA	
Ref.	Dimensões Centímetro	Ref.	Dimensões Centímetro	Ref.	Dimensões Centímetro	Ref.	Dimensões Centímetro	Ref.	Dimensões Centímetro
PU 14 C	36	PU 14 Z	36	PU 14 P	36	PU 14 HG	36	PU 14 F	36
PU 18 C	46	PU 18 Z	46	PU 18 P	46	PU 18 HG	46	PU 18 F	46
PU 21 C	54	PU 21 Z	54	PU 21 P	54	PU 21 HG	54	PU 21 F	54
PU 24 C	61	PU 24 Z	61	PU 24 P	61	PU 24 HG	61	PU 24 F	61



## Rodízios

Ruedas y rodajas // Castors and wheels

REVESTIMENTO DE BORRACHA	BENEFICIAMENTO	TIPO	REFERÊNCIA	KG	mm	mm			
	ZINCO C/VERNIZ PARA CÂMARA FRIA	ZINCADO	SIMPLES	GER 312 BPKC C/ ESPIGA GE2R	60	100	66	3"	1".1/4"
GER 412 BPKC C/ ESPIGA GE2R				80	125	92	4"	1".1/4"	
GER 512 BPKC C/ ESPIGA GE2R				90	155	105	5"	1".1/4"	
COM FREIO			GEROA 312 BPKC C/ ESPIGA GE2R	60	100	66	3"	1".1/4"	
			GERON 412 BPKC C/ ESPIGA GE2R	80	125	92	4"	1".1/4"	
			GERON 512 BPKC C/ ESPIGA GE2R	90	155	105	5"	1".1/4"	
ZINCO C/VERNIZ PARA CÂMARA FRIA		SIMPLES	SIMPLES	GER 312 BPKC C/ ESPIGA GE2R	60	100	66	3"	1".1/4"
				GER 412 BPKC C/ ESPIGA GE2R	80	125	92	4"	1".1/4"
				GER 512 BPKC C/ ESPIGA GE2R	90	155	105	5"	1".1/4"
		COM FREIO	COM FREIO	GEROA 312 BPKC C/ ESPIGA GE2R	60	100	66	3"	1".1/4"
				GERON 412 BPKC C/ ESPIGA GE2R	80	125	92	4"	1".1/4"
				GERON 512 BPKC C/ ESPIGA GE2R	90	155	105	5"	1".1/4"



## Presilhas

Abrazadera // Clamp

PRESILHA 'W' CROMADA	PRESILHA 'W' ZINCADA	PRESILHA 'W' PINTADA	PRESILHA 'W' HIGH GLOSS	PRESILHA 'W' CÂM. FRIA
Ref. PR-W-C	Ref. PR-W-Z	Ref. PR-W-P	Ref. PR-W-HG	Ref. PR-W-F

PRESILHA 'S' CROMADA	PRESILHA 'S' ZINCADA	PRESILHA 'S' PINTADA	PRESILHA 'S' HIGH GLOSS	PRESILHA 'S' CÂM. FRIA
Ref. PR-S-C	Ref. PR-S-Z	Ref. PR-S-P	Ref. PR-S-HG	Ref. PR-S-F

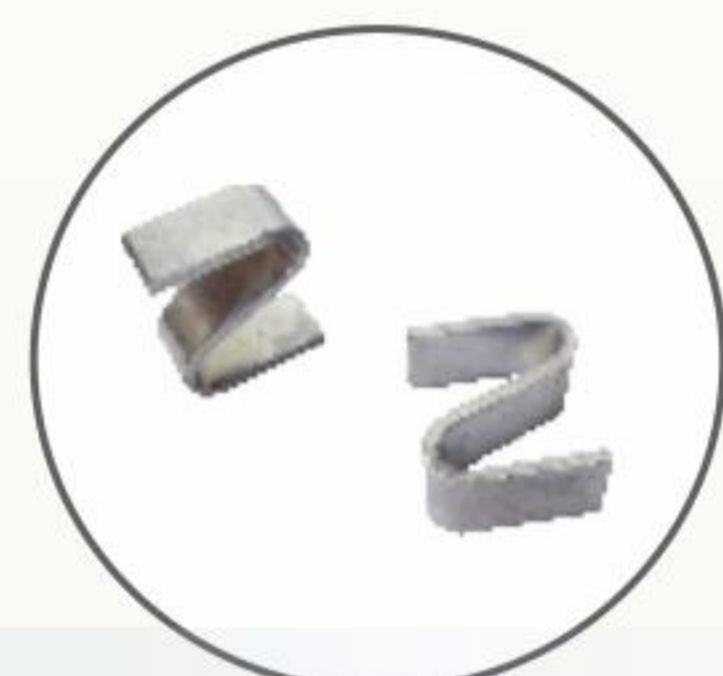

## Utilitário - Expositor p/ Vinho

Utilitário - expositor del vino // Utilitário - wine cradle



CARRO UTILITÁRIO CROMADO	MEDIDA	BANDEJA
	88 x 49 x 88cm	46 x 77cm



EXPOSITOR PARA VINHOS	MEDIDA	BANDEJA
	36 x 77 x 72cm	18 Garrafas

# SUPERMERCADO

Supermercado // Supermarket

**HighGloss**  
Acabamento exclusivo Rod-Car®

PROTECTION THAT LIVES ON  
**MICROBAN**



## ENCAIXE DE CARRINHOS

Os carrinhos da série B, possuem uma estrutura especialmente desenvolvida para que quando encaixados ocupem menor área nobre que os carrinhos convencionais. Isso possibilita a otimização do espaço do ponto e venda, independente da dimensão física que esses dispõem.

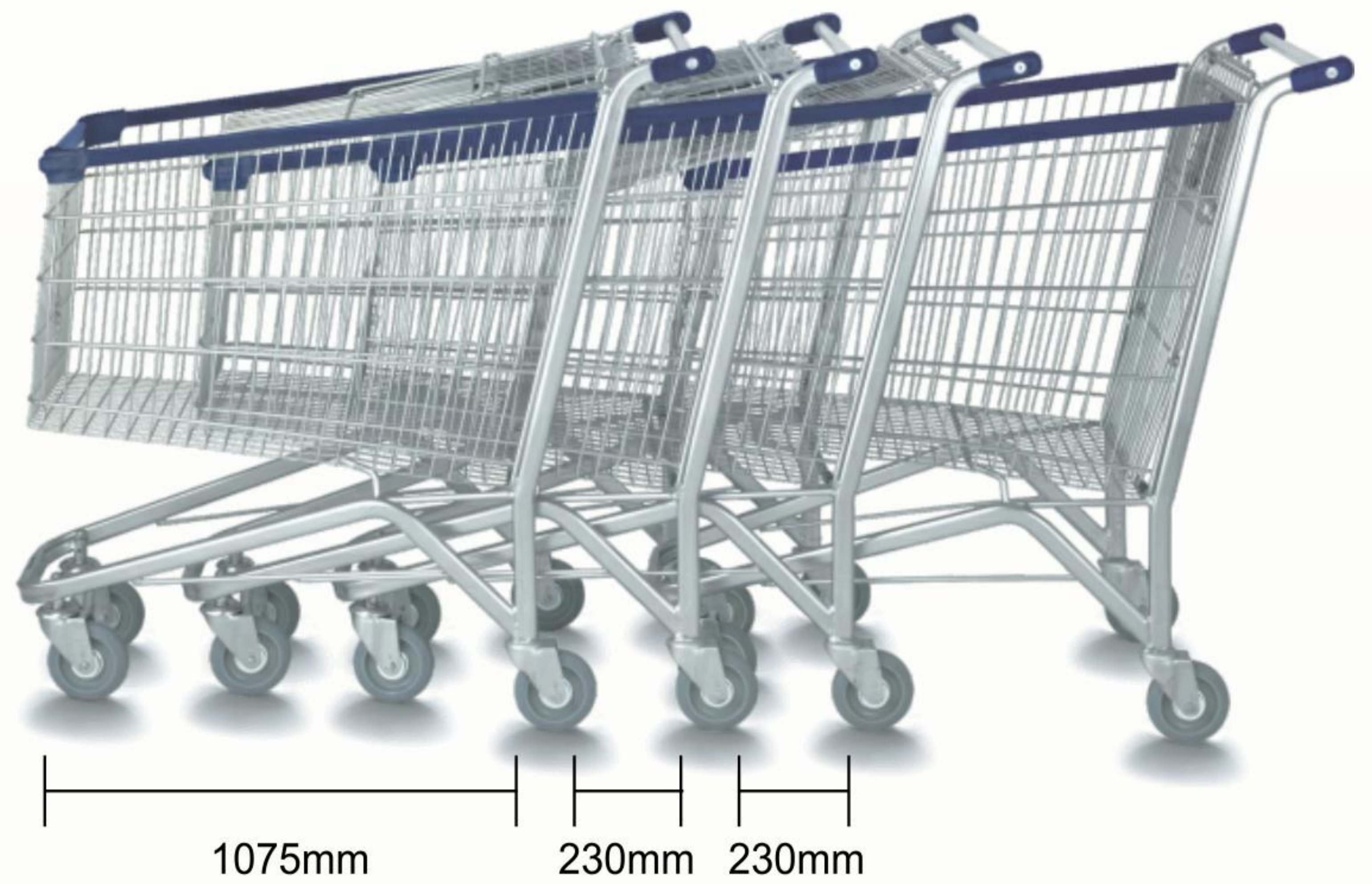

## Bebê-Conforto

Cuna para bebê // Baby seat



### Bebê-conforto anatômico com capacidade para 10 kg

Cuna para bebê anatômico  
capacidad 10 kilos de cargo

Baby seat 10 kg capacity



## ACABAMENTO

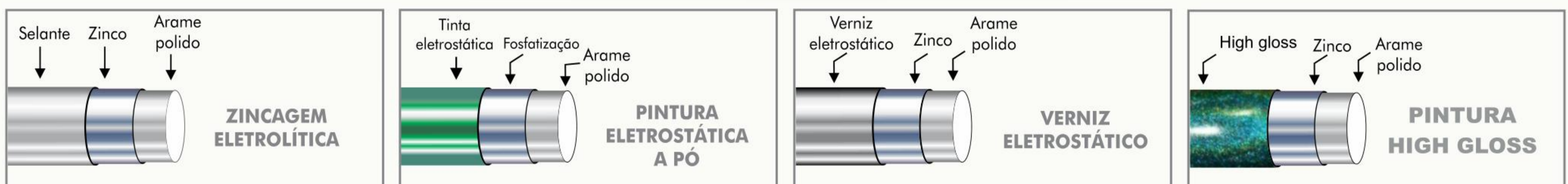

Pintado



Zincado



Zinco com verniz



Pintado High Gloss



Zink coat



## CORES DISPONÍVEIS PARA FRISO, ASSENTOS E ORELHAS

Colores disponibles para friso, asiento y tops plásticos



**AMARELO**

Amarillo / Yellow



**LARANJA**

Naranja / Orange



**VERMELHO**

Rojo / Red



**VERDE**

Verde / Green



**AZUL**

Azul / Blue



**CINZA**

Gris / Grey



**PRETO**

Negro / Black



*Diferenciais exclusivos que beneficiam tanto os supermercadistas quanto os consumidores finais!*



**D**esenvolvido para oferecer um maior conforto aos clientes, o novo cabo para carrinhos de supermercado da Rod-Car® é mais estético, moderno e ergonômico, seu formato permite um melhor apoio para as mãos, isso proporciona maior firmeza no manuseio dos carrinhos.

\*Componente opcional, disponível para as linhas: B3, B4 e Duplocar.

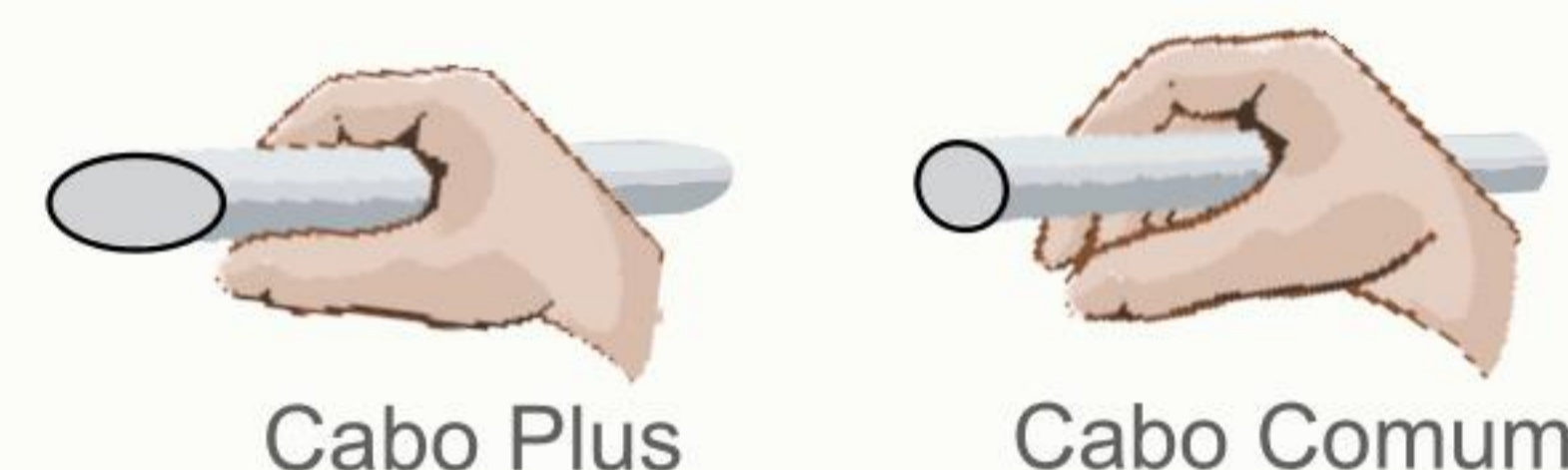

**D**esenvolvido através de testes de melhoria contínua do produto, o processo de acabamento de superfície High Gloss (Composto Exclusivo Rod-Car®), oferece aos carrinhos de clientes maior proteção contra oxidação, aumentando sua durabilidade e representando um excelente custo x benefício.

As cores exclusivas da linha High Gloss proporcionam maior atratividade, além de ser uma extensão da comunicação visual da loja, proporciona maior visibilidade e valoriza ainda mais os investimentos empregados para diferenciação do seu comércio.



**T**odos os nossos produtos com acabamento em pintura eletrostática recebem o aditivo antimicrobiano Microban®. Sendo o carrinho de Supermercado classificado como um dos equipamentos mais contaminados do mundo e estando a Rod-Car® na vanguarda do segmento, iniciamos uma parceria exclusiva e inédita com a empresa líder mundial em soluções antimicrobianas, a Microban®. O Aditivo Microban® é incorporado durante o processo de pintura, tornando-se parte integrante do produto e protegendo toda a superfície do carrinho. Inibindo continuamente a proliferação de fungos e bactérias, o aditivo Microban® evita a contaminação alimentar e a contaminação cruzada.

**Confira!**  
a ilustração ao lado mostra a ação do aditivo Microban®

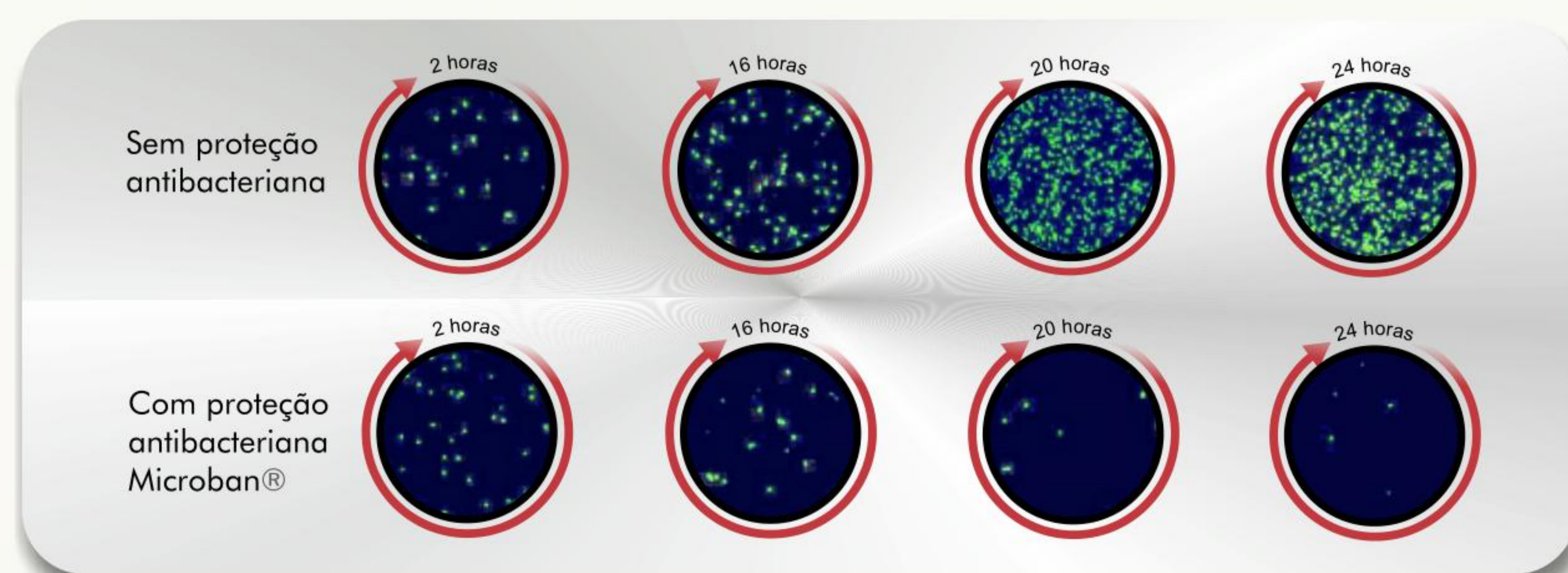

## Carros de Auto-Serviço - Linha B3 - Sem Estrado

Carros de autoservicio - linea B3 - sin rejilla inferior // Shopping cart - B3 line - without lower tray



**B3 80 L**



**B3 90 L**



**B3 130 L**



**\*B3 160 L**



**\*B3-B 160 L**



**\*B3-BBC 210 L**

CAPACIDADE	REFERÊNCIA	DESCRIÇÃO
80 litros	B3	Sem porta-bebê
90 litros	B3	Sem porta-bebê
90 litros	B3-B	Com porta-bebê
130 litros	B3	Sem porta-bebê
130 litros	B3-B	Com porta-bebê

CAPACIDADE	REFERÊNCIA	DESCRIÇÃO
160 litros	B3 - B	Com porta-bebê
160 litros	B3-BBC	Com bebê conforto
210 litros	B3	Sem porta-bebê
210 litros	B3 - B	Com porta-bebê
210 litros	B3-BBC	Com bebê conforto

## Carros de Auto-Serviço - Linha B3 - Com Estrado

Carros de autoservicio - linea B3 - con rejilla inferior // Shopping cart - B3 line - with lower tray



**B3-E 90 L**



**B3-E 130 L**



**\*B3-E 160 L**



**\*B3-BE 160 L**



**\*B3-BBCE 210 L**

CAPACIDADE	REFERÊNCIA	DESCRIÇÃO
90 litros	B3-E	Sem porta-bebê
90 litros	B3-BE	Com porta-bebê
130 litros	B3-E	Sem porta-bebê
130 litros	B3-BE	Com porta-bebê
160 litros	B3-E	Sem porta-bebê

CAPACIDADE	REFERÊNCIA	DESCRIÇÃO
160 litros	B3-BE	Com porta-bebê
160 litros	B3-BBCE	Com bebê conforto
210 litros	B3-E	Sem porta-bebê
210 litros	B3-BE	Com porta-bebê
210 litros	B3-BBCE	Com bebê conforto

### Informações Técnicas

Información Técnica // Information

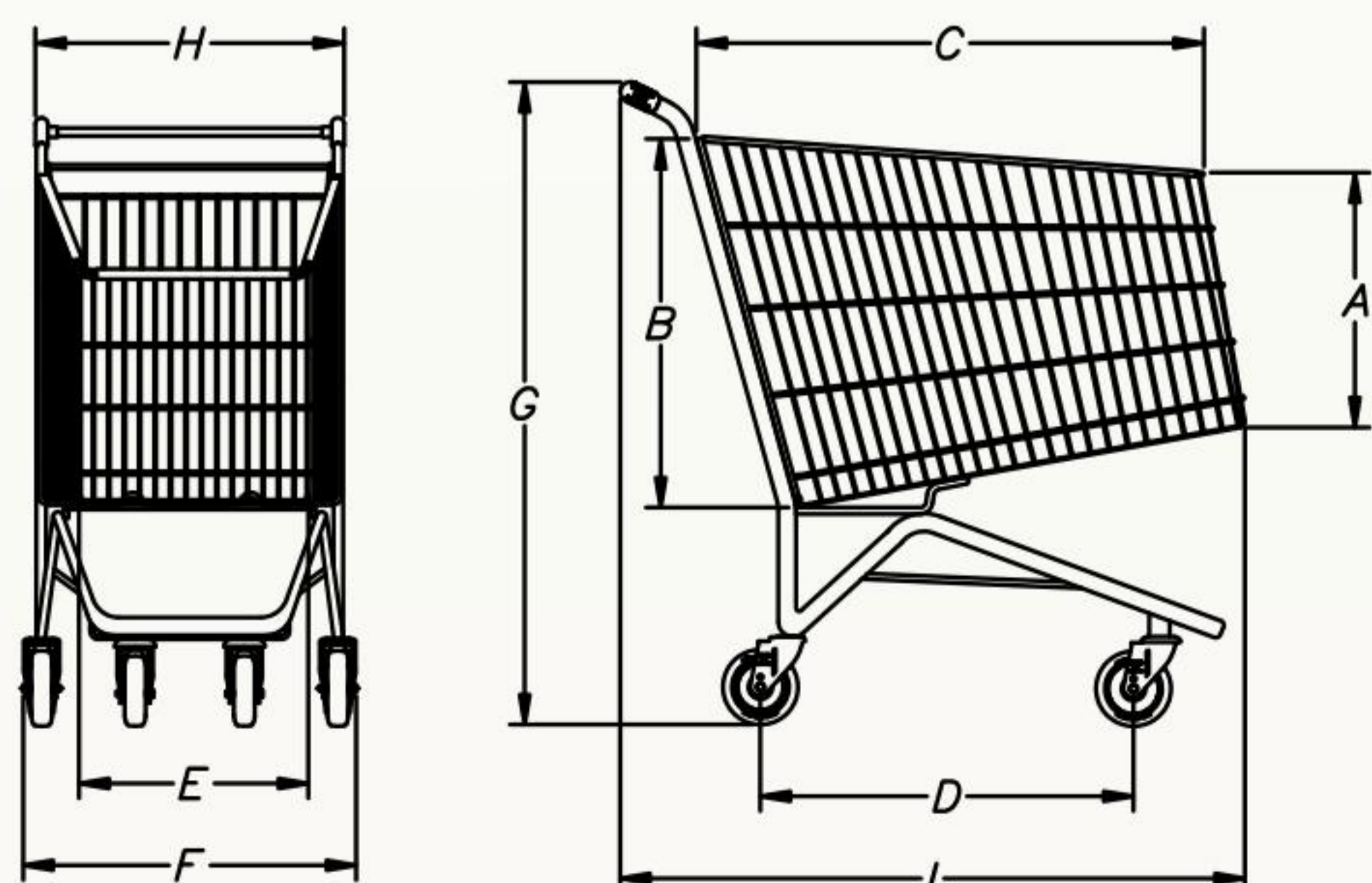

#### Medida: comprimento x largura x altura

Medida: largo x ancho x alto / Measurements: length x width x height

CAPACIDADE EM LITROS	DIMENSIONAIS B3 (mm)								
	A	B	C	D	E	F	G	H	I
80 Litros	200	350	630	660	370	520	970	510	880
90 Litros	285	450	780	660	375	505	975	485	970
130 Litros	380	560	800	600	395	550	1065	515	1080
160 Litros	335	535	850	740	400	580	1065	575	1080
210 Litros	430	630	875	740	440	580	1065	575	1080

\*Os carros B3 160L e 210L estão disponíveis com a opção de roda para esteira rolante AU2KCN autoblock.



**B4 160 L**



**\*B4-B 180 L**



**\*B4-BBC 210 L**



\*Roda para esteira rolante  
AU2KCN autoblock  
Item opcional disponível para a linha B3 e B4  
Não disponível para o B4 160L

CAPACIDADE	REFERÊNCIA	DESCRIÇÃO
160 litros	B4	Sem porta-bebê
160 litros	B4 - B	Com porta-bebê
160 litros	B4-BBC	Com bebê conforto
180 litros	B4	Sem porta-bebê
180 litros	B4 - B	Com porta-bebê

CAPACIDADE	REFERÊNCIA	DESCRIÇÃO
180 litros	B4-BBC	Com bebê conforto
210 litros	B4	Sem porta-bebê
210 litros	B4 - B	Com porta-bebê
210 litros	B4-BBC	Com bebê conforto

## Carros de Auto-Serviço - Linha B4 - Com Estrado

Carros de autoservicio - linea B4 - con rejilla inferior // Shopping cart - B4 line - with lower tray



**B4-E 160 L**



**\*B4-BE 180 L**



**\*B4-BBCE 210 L**

CAPACIDADE	REFERÊNCIA	DESCRIÇÃO
160 litros	B4-E	Sem porta-bebê
160 litros	B4 - BE	Com porta-bebê
160 litros	B4-BBCE	Com bebê conforto
180 litros	B4-E	Sem porta-bebê
180 litros	B4-BE	Com porta-bebê

CAPACIDADE	REFERÊNCIA	DESCRIÇÃO
180 litros	B4-BBCE	Com bebê conforto
210 litros	B4-E	Sem porta-bebê
210 litros	B4-BE	Com porta-bebê
210 litros	B4-BBCE	Com bebê conforto

### Informações Técnicas

Información Técnica // Information

Medida: comprimento x largura x altura

Medida: largo x ancho x alto // Measurements: length x width x height

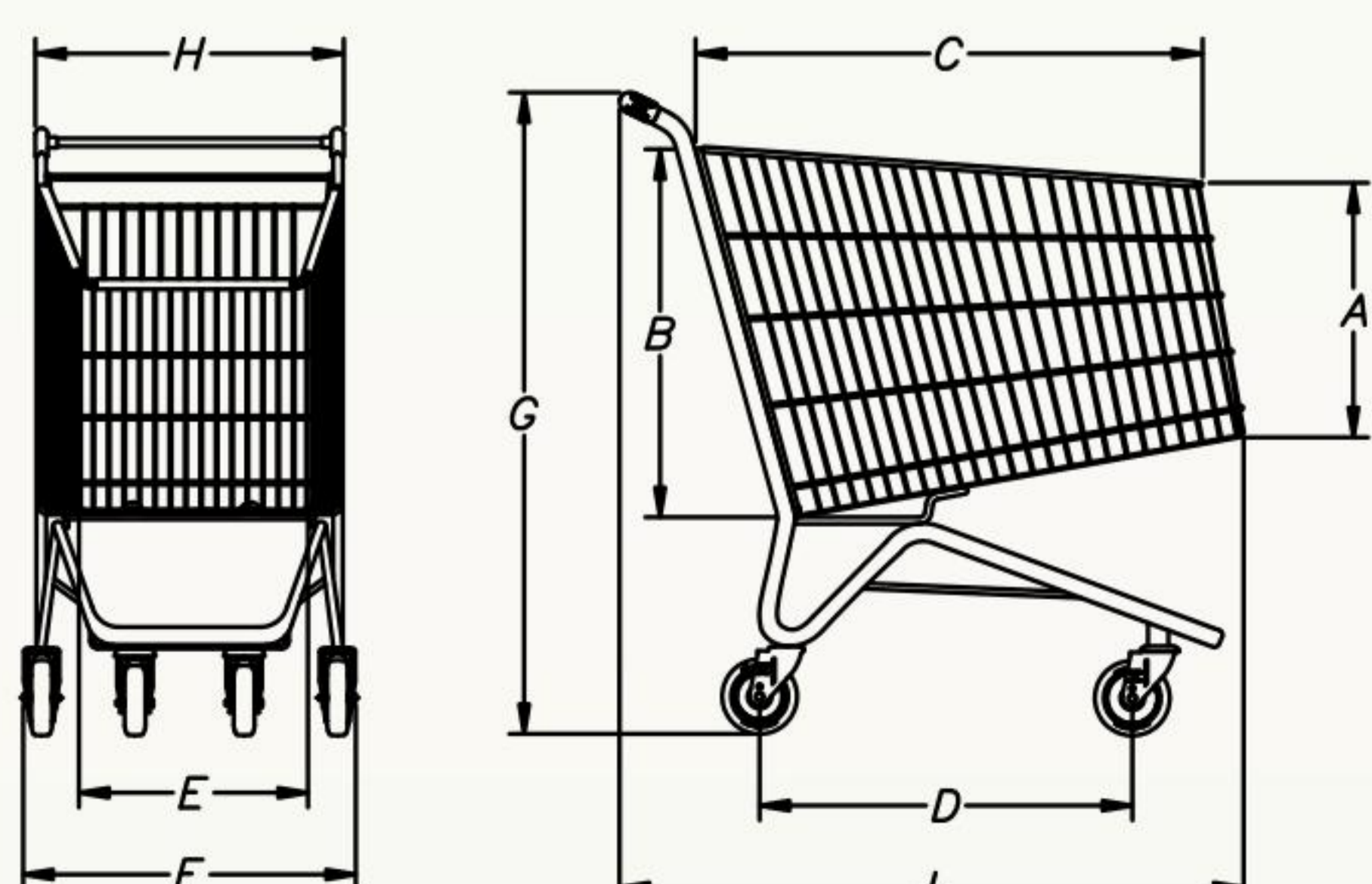

CAPACIDADE EM LITROS	DIMENSIONAIS B4 (mm)								
	A	B	C	D	E	F	G	H	I
160 Litros	370	545	775	540	400	520	1010	540	950
180 Litros	405	610	860	700	400	515	1075	540	1035
210 Litros	410	615	865	700	400	515	1075	540	1035

\*Os carros B4 180L e 210L estão disponíveis com a opção de roda para esteira rolante AU2KCN autoblock.



## Carros de Auto-Serviço - Linha Duplocar - Sem Estrado

Carros de autoservicio - linea duplocar - sin rejilla inferior // Two basket shopping cart - without lower tray



CAPACIDADE	REFERÊNCIA	DESCRIÇÃO	CAPACIDADE	REFERÊNCIA	DESCRIÇÃO
50 litros	Duplocar 50 Litros	Carro com Duplo Cesto	120 litros	*Duplocar 120 Litros	Carro com Duplo Cesto
90 litros	Duplocar 90 Litros	Carro com Duplo Cesto	160 litros	*Duplocar 160 Litros	Carro com Duplo Cesto

## Carros de Auto-Serviço - Linha Duplocar - Com Estrado

Carros de autoservicio - linea duplocar - con rejilla inferior // Two basket shopping cart - with lower tray



Os carrinhos da série Duplocar possuem design moderno, com abertura ideal entre os cestos que permitem um melhor manuseio das mercadorias proporcionando mais conforto e ergonomia a seus clientes



\*Roda para esteira rolante AU2KCN autoblock  
Item opcional disponível para a linha Duplocar 120L e 160L  
Não disponível para Duplocar 50L e 90L



CAPACIDADE	REFERÊNCIA	DESCRIÇÃO	CAPACIDADE	REFERÊNCIA	DESCRIÇÃO
120 litros	*Duplocar-E 120 litros	Carro c/ Duplo Cesto e Estrado	160 litros	*Duplocar-E 160 Litros	Carro c/ Duplo Cesto e Estrado

### Informações Técnicas

Información Técnica // Information

Medida: comprimento x largura x altura

Medida: largo x ancho x alto / Measurements: length x width x height

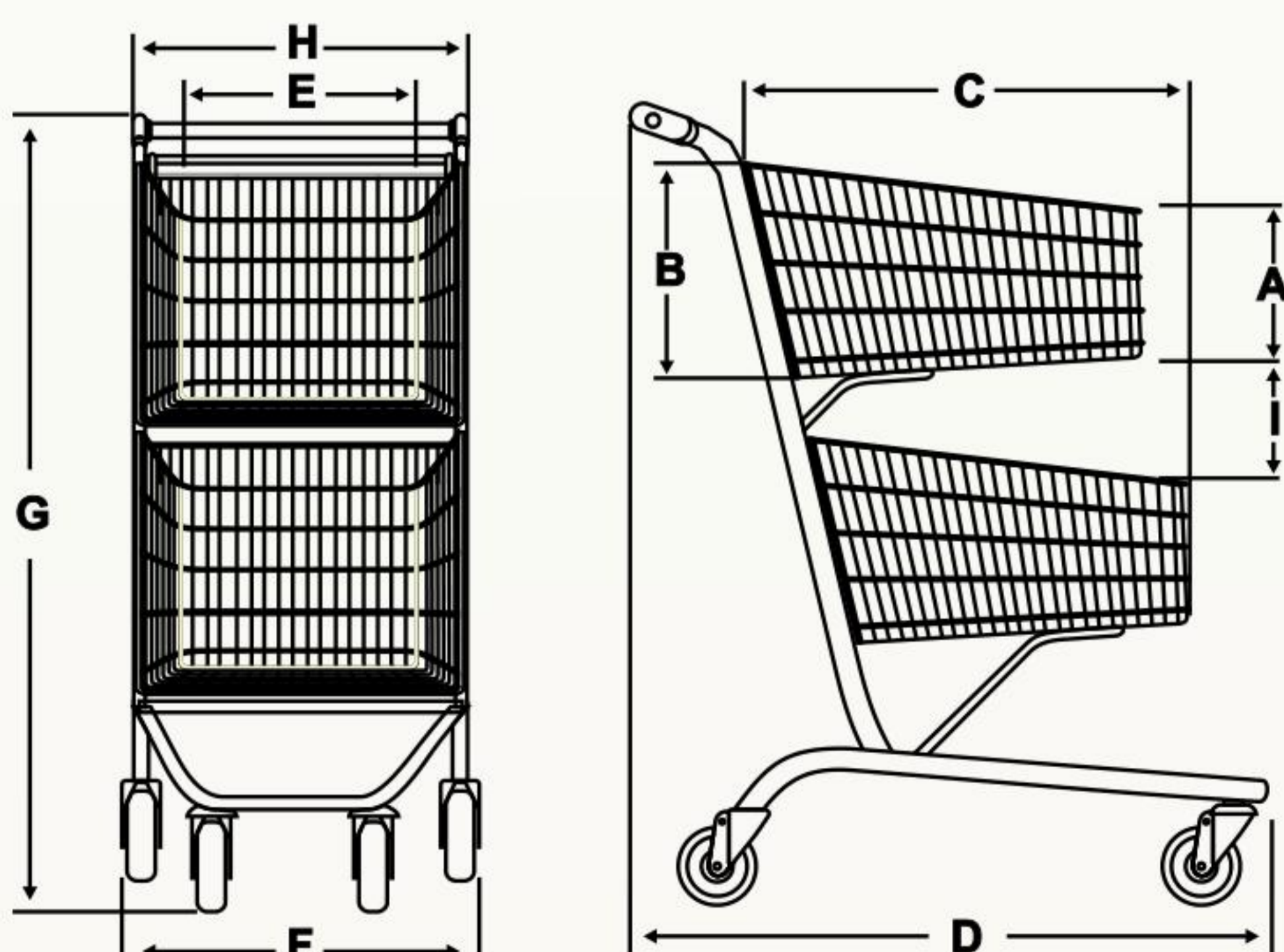

CAPACIDADE EM LITROS	DIMENSIONAIS DUPLOCAR (mm)								
	A	B	C	D	E	F	G	H	I
50 Litros	150	230	750	930	260	495	1030	395	315
90 Litros	195	345	790	980	295	510	1100	445	305
120 Litros	205	340	835	990	375	580	1100	535	265
160 Litros	205	340	905	1020	375	580	1130	540	280

\*Os carros Duplocar 120L e 160L estão disponíveis com a opção de roda para esteira rolante AU2KCN autoblock.



\*Roda para esteira rolante  
AU2KCN autoblock  
Item opcional disponível para a linha Maxicar



CAPACIDADE	REFERÊNCIA	DESCRIÇÃO
200 litros	Maxicar	Sem porta-bebê
200 litros	Maxicar - B	Com porta-bebê

CAPACIDADE	REFERÊNCIA	DESCRIÇÃO
200 litros	Maxicar - E	Com estrado e sem porta-bebê
200 litros	Maxicar - BE	Com estrado e com porta-bebê

**Informações Técnicas**

Información Técnica // Information

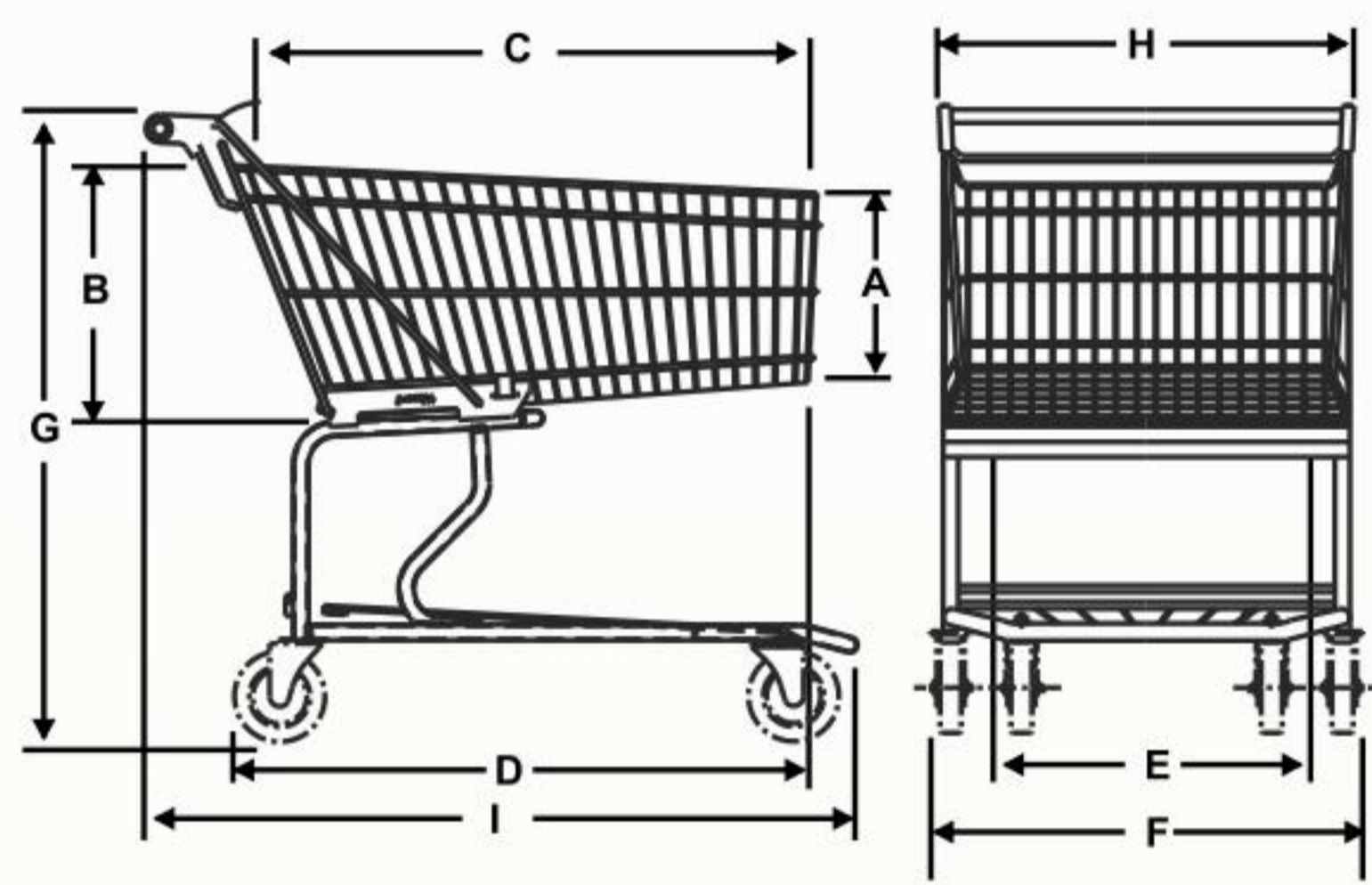

**Medida: comprimento x largura x altura**

Medida: largo x ancho x alto / Measurements: length x width x height

CAPACIDADE EM LITROS	DIMENSIONAIS MAXICAR (mm)								
	A	B	C	D	E	F	G	H	I
200 Litros s/ estrado	300	420	950	940	590	750	920	730	1090
200 Litros c/ estrado	300	420	950	940	590	725	990	730	1090

**Linha B3 - 150 Litros**

Linea B3 - 150 litros // Wholesalers shopping cart

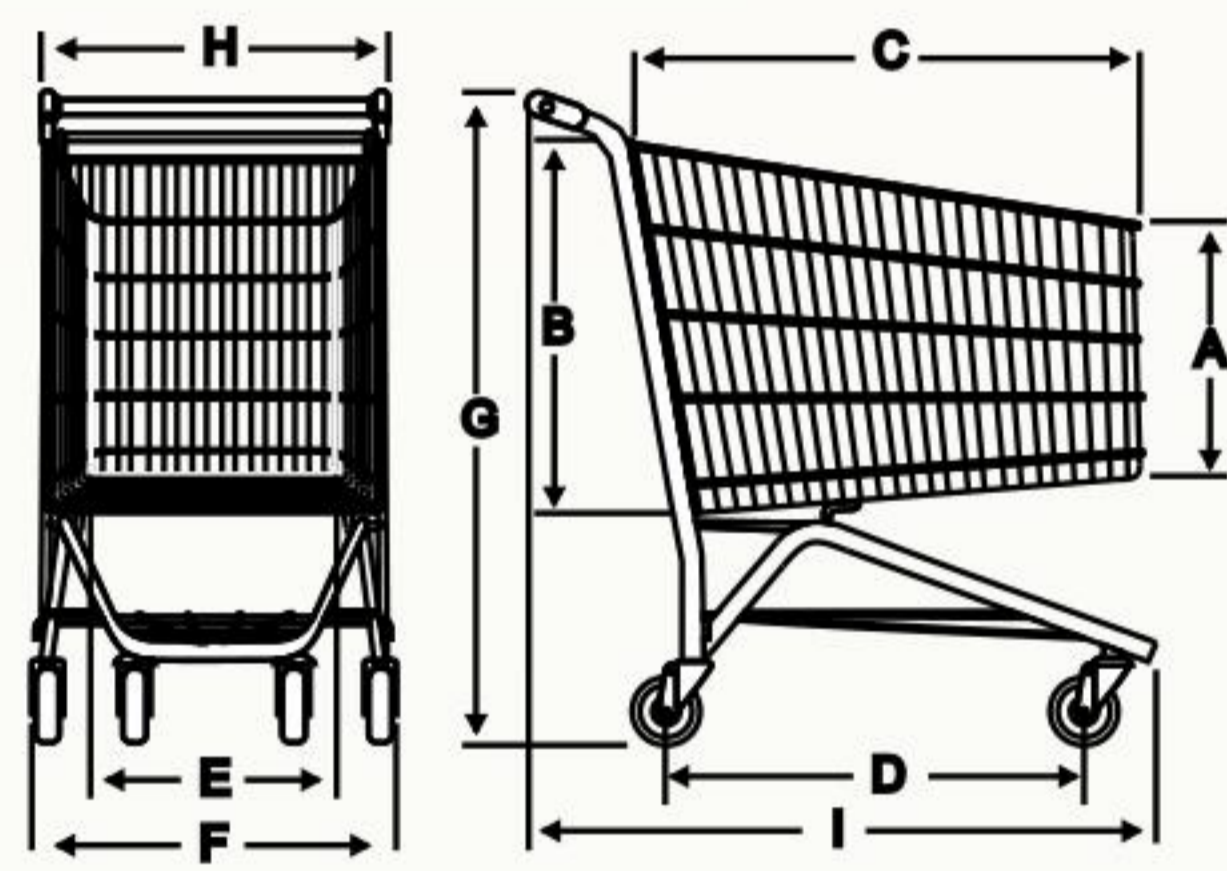

**Informações Técnicas**

Información Técnica // Information



\*Roda para esteira rolante  
AU2KCN autoblock  
Item opcional disponível para a linha B3 150L



**Medida: comprimento x largura x altura**

Medida: largo x ancho x alto // Measurements: length x width x height

CAPACIDADE EM LITROS	DIMENSIONAIS B3 (mm)								
	A	B	C	D	E	F	G	H	I
150 Litros	300	420	830	850	525	690	1015	645	1020

CAPACIDADE	REFERÊNCIA	DESCRIÇÃO
150 litros	B3	Sem porta-bebê

**Carros de Auto-Serviço Atacado - Linha Macrocar**

Carros de autoserviço y mayorista - linea Macrocar // Wholesalers shopping cart

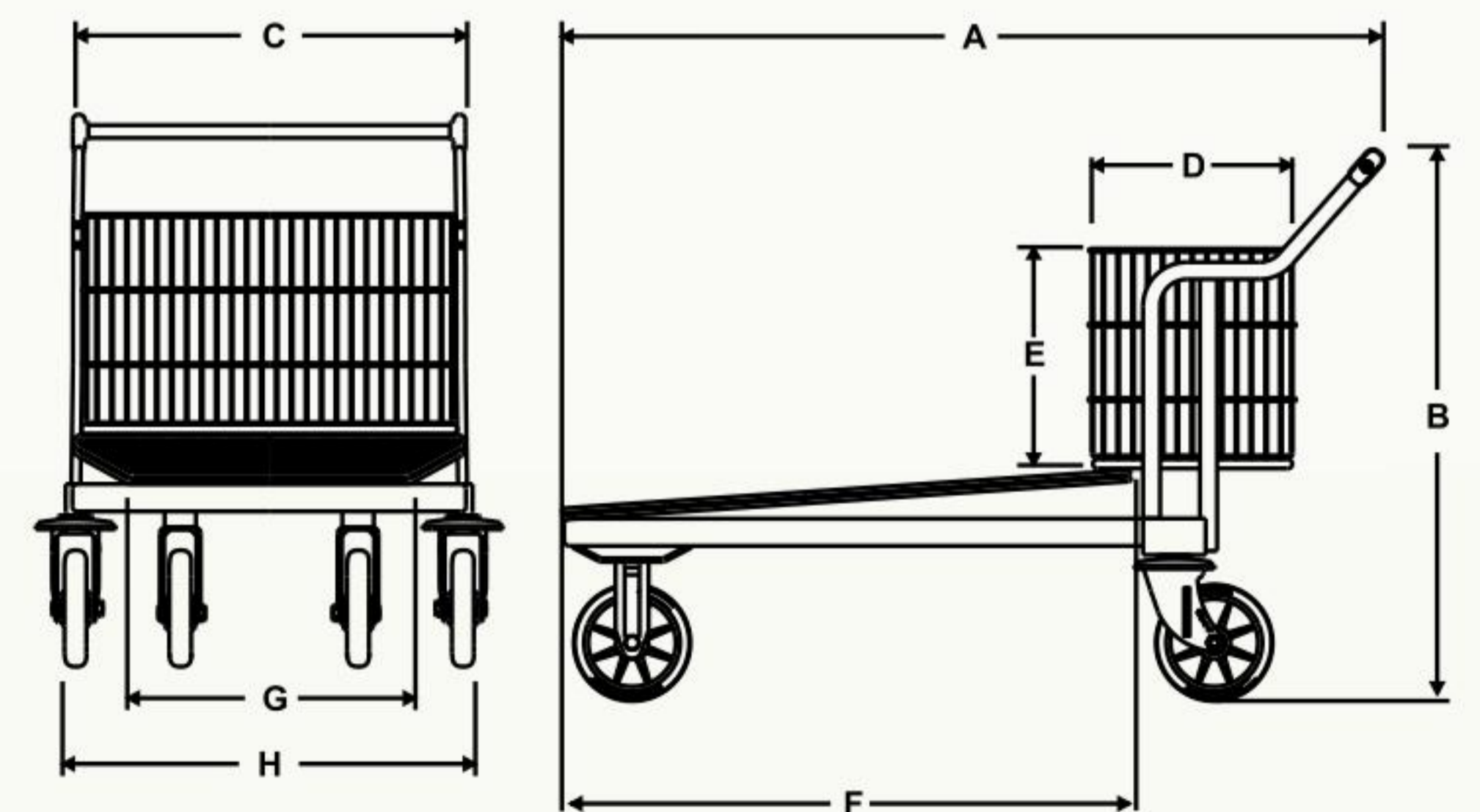

**Informações Técnicas**

Información Técnica // Information

**Medida: comprimento x largura x altura**

Medida: largo x ancho x alto // Measurements: length x width x height

DIMENSIONAIS MACROCAR (mm)							
A	B	C	D	E	F	G	H
1475	980	685	365	375	1020	525	750

# Acessório p/Supermercados - Cestos e Porta Cestos

Canastos // Baskets



**Cesta Plástica com alça plástica**



**Cesta Plástica com alça de arame**



**Cesta Aramada**



**Cesta Aramada**



**Cesta Plástica**



**Porta Cestos Simples s/ Roda**

Med.: 400 x 490 x 1115 mm



**Porta Cestos Duplo c/ Roda**

Med.: 840 x 510 x 1180 mm

Obs: Cestos vendidos separadamente

CAPACIDADE	REFERÊNCIA	DESCRIÇÃO
15 kg	Cesta Plástica	Cesta Plástica c/ alça plástica
15 kg	Cesta Plástica	Cesta Plástica c/ alça de arame
15 kg	Cesta Aramada	Cesta Aramada com limitador
25 kg	Cesta Aramada	Cesta Aramada com rodas

CAPACIDADE	REFERÊNCIA	DESCRIÇÃO
25 kg	Cesta Plástica	Cesta Plástica com rodas
25 Peças	*Porta Cestos	Porta Cestos simples
50 Peças	*Porta Cestos	Porta Cestos Duplo

\*Porta cestos disponíveis nas versões com ou sem rodas

## Expositores

Exibidores // Displays



**Expositor Redondo pequeno**

Med.: 600 x 1460 mm

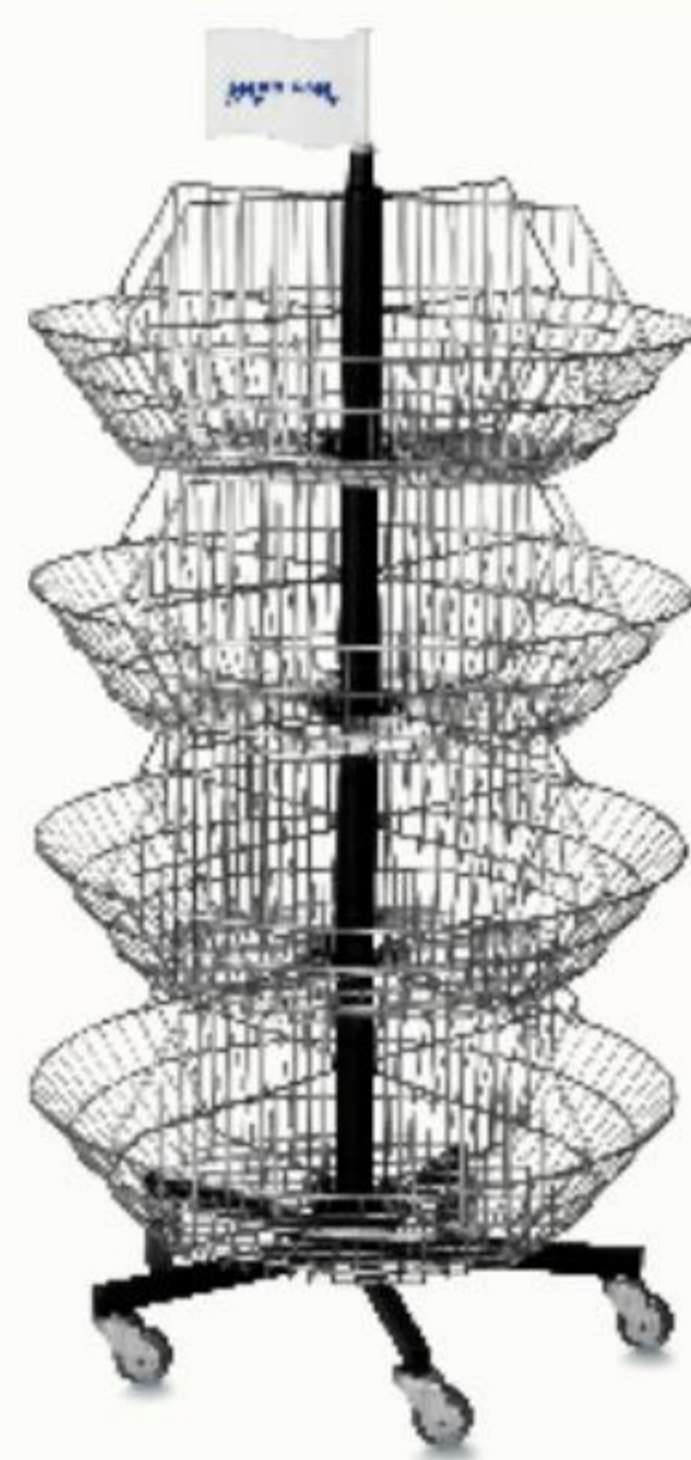

**Expositor Redondo grande**

Med.: 850 x 1710 mm



**Ovotainer**

Med.: 990 x 650 x 1720 mm

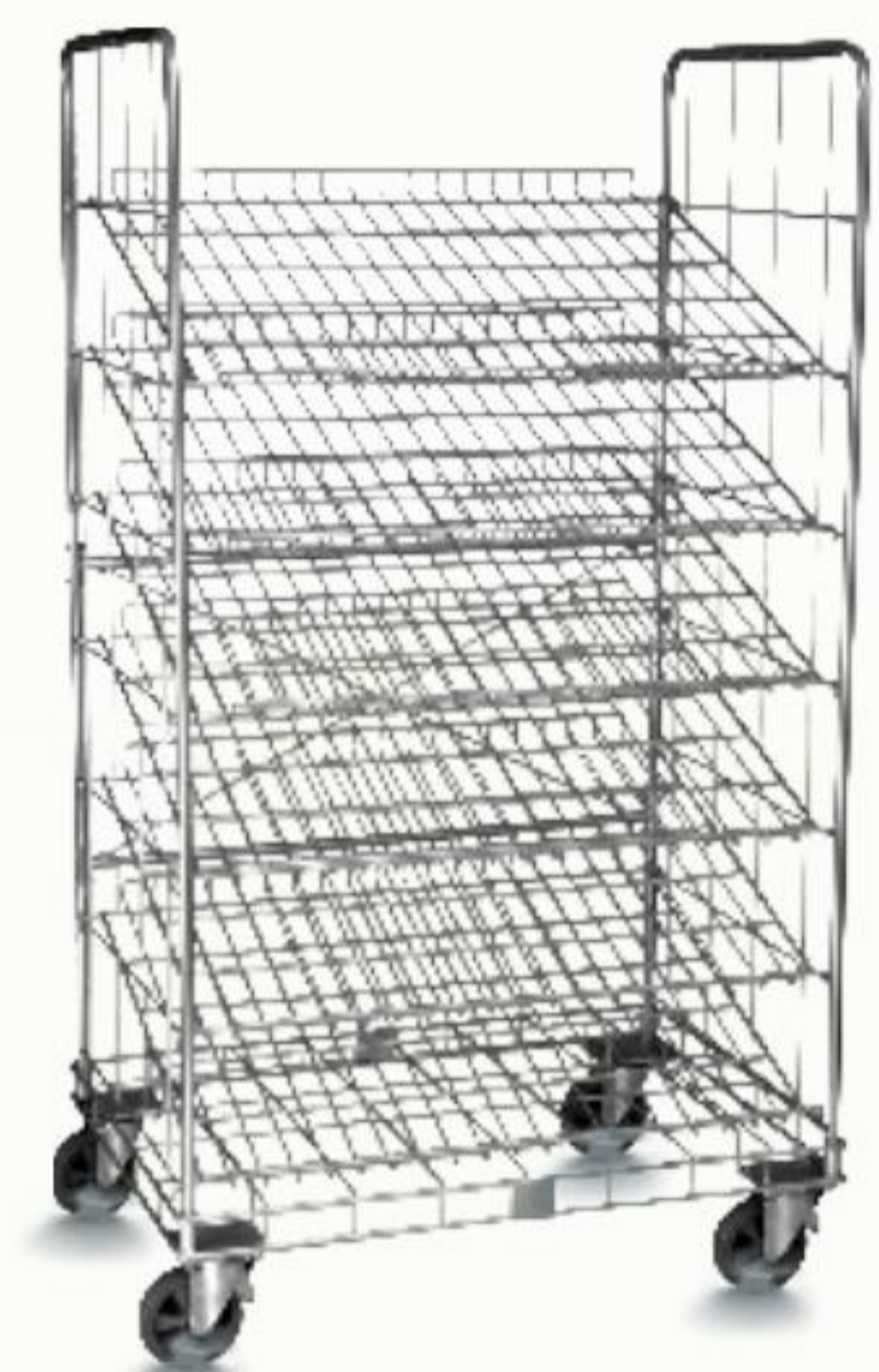

**Formatainer**

Med.: 1050 x 700 x 1850 mm

REFERÊNCIA	DESCRIÇÃO
Expositor Redondo	Expositor Redondo pequeno
Expositor Redondo	Expositor Redondo grande

REFERÊNCIA	DESCRIÇÃO
Ovotainer	Expositor para ovos
Formatainer	Expositor para pães

## Expositores FLV

Exibidores FLV // Fruit and vegetables displays



**Expositor para Embutidos**

Med.: 1200 x 1000 x 1120 mm



**8 Caixas**



**16 Caixas**

MEDIDA	REFERÊNCIA	DESCRIÇÃO
600 x 1600 x 1320	Expositor de F.L.V	Expositor de F.L.V 04 caixas
1200 x 1600 x 1320	Expositor de F.L.V	Expositor de F.L.V 08 caixas
1800 x 1600 x 1320	Expositor de F.L.V	Expositor de F.L.V 12 caixas
2400 x 1600 x 1320	Expositor de F.L.V	Expositor de F.L.V 16 caixas

**Estacicar Grande**



Roda: 680 x 820 x 1020 mm  
Pneu: 650 x 820 x 1040 mm  
Cesto: 520 x 625 mm

**Estacicar Pequeno**



Roda: 680 x 720 x 1020 mm  
Pneu: 650 x 720 x 1040 mm  
Cesto: 520 x 520 mm

**Caixacar**



Med.: 700 x 460 x 1085 mm



**Disponíveis com  
Roda Pneumática**

**Carros de Apoio - Carro para Condomínio e Cubacar**

Carros de apoio - condominio y carro con tina plástica // Condominium cart



**Carro Cubacar**

Carro com estrutura zincada ou em inox, ideal para cozinhas, frigoríficos e preparação de alimentos. Cuba Plástica adequada a norma alimentar.

Capacidade para 180 Litros.  
Obs: (Vendida separadamente)



Med.: 1000 x 550 x 930 mm

**Carro Condomínio**

Carrinho ideal para o uso em prédios, condomínios ou conjuntos habitacionais. Oferece a possibilidade de personalização com o logotipo do supermercado para quantidades acima de 50 peças.

Capacidade para 140 Litros



Med.: 900 x 530 x 940 mm

CAPACIDADE	REFERÊNCIA	DESCRIÇÃO
180 L	Cubacar	Carro Cubacar

CAPACIDADE	REFERÊNCIA	DESCRIÇÃO
140 L	Carro Condomínio	Carro para Condomínio

**Carros de Apoio - Carros Abastecedor de Gôndola / Armazém**

Carros de transporte // Backroom carts

**55-A**



Med.: 1160 x 620 x 1710 mm

**55-B**



Med.: 1500 x 620 x 1035 mm



Med.: 610 x 520 x 1275 mm

**13-4R**



Med.: 1200 x 610 x 1000 mm

CAPACIDADE	REFERÊNCIA	DESCRIÇÃO
300kg	55-A	Carro Abastecedor de gôndola alto
300kg	55-B	Carro Abastecedor de gôndola baixo

CAPACIDADE	REFERÊNCIA	DESCRIÇÃO
300 Kg	13-4R	Carro Armazém

## Carros de Auto-Serviço - Linha Infantil e Linha Especial Deficiente

Carritos para niño y para sillas con ruedas // Kids carts



**\*Rod Kart**



**Kids Car**



**Carro para Deficiente**

CAPACIDADE	REFERÊNCIA	DESCRIÇÃO
50 litros	Carro kids Car	Carro Infantil
60 litros	Carro para Deficiente	Carro para deficiente

CAPACIDADE	REFERÊNCIA	DESCRIÇÃO
160 litros	Rod Kart	Carro Infantil com brinquedo

## Carros para Abastecimento - Abastecicar

Carros de transporte // Stock carts

**Abastecicar Fundo Grande sem Etiquetador**



Med.: 1250 x 680 x 1040 mm

**Abastecicar Fundo Pequeno sem Etiquetador**



Med.: 950 x 650 x 1040 mm

**Abastecicar Alto**



Med.: 910 x 500 x 1000 mm

CAPACIDADE	REFERÊNCIA	DESCRIÇÃO
430 litros	ABASTECICAR - F/G/S/E	Abastecicar grd. s/etiquetador
430 litros	ABASTECICAR - F/G/C/E	Abastecicar grd. c/etiquetador

CAPACIDADE	REFERÊNCIA	DESCRIÇÃO
260 litros	ABASTECICAR - F/P/S/E	Abastecicar peq. s/etiquetador
260 litros	ABASTECICAR - F/P/C/E	Abastecicar peq. c/etiquetador
	ABASTECICAR ALTO	Abastecicar Alto

## Carros para Abastecimento - Carro Bandeja e Carro Dupla Plataforma

Carros de transporte - Doble plataforma // Backroom carts

Escada articulável para apoio na reposição de produtos

Escalenas Articulables



**Carro Bandeja com escada**  
Med.: 1610 x 585 x 1075 mm



**Carro Dupla Plataforma**  
Med.: 1100 x 600 x 805 mm

\*O carro Rod Kart 160L está disponível com a opção de roda para esteira rolante AU2KCN autoblock.



**\*Ideal para vasilhames e PET**

CAPACIDADE	REFERÊNCIA	DESCRIÇÃO
500 Kg	STE-M	Stock tainer estrutural



**\*Opção em inox e aço carbono**

CAPACIDADE	REFERÊNCIA	DESCRIÇÃO
500 Kg	STF-C	Stock tainer farinacio



**\*Ideal para cereais**

CAPACIDADE	REFERÊNCIA	DESCRIÇÃO
900 Kg	STA-C	Stock tainer alto



CAPACIDADE	REFERÊNCIA	DESCRIÇÃO
400 Kg	STA-C	Stock tainer alto

**ROLL CAR**

Carros ideal para o transporte de mercadorias para abastecimento de loja. Possui base em madeira com rodas e estrutura metálica com abas móveis.

\*Opção de base em tela aramada.

Med.: 1080 x 605 x 1780 mm



**ROLLCONTAINER**

Carros Aramados ideal para o transporte de mercadorias. Possuem bandeja divisória, sistema de freio nas rodas traseiras, portas e dispositivo para tracionamento. São dobráveis e encaixáveis.

Med.: 800 x 1000 x 2000 mm



CAPACIDADE	REFERÊNCIA	DESCRIÇÃO
500 kg	Roll Car	Carro p/tranp. de mercadorias

CAPACIDADE	REFERÊNCIA	DESCRIÇÃO
500 kg	Roll Container	Carro aramados p/transporte

**BASES MULTI-USO**

Plataforma de Madeira - Plataforma Metálica  
Multipurpose base

**Base de Madeira**  
1200 x 800 x 150 mm



**Base de Chapa Zincada**  
1200 x 800 x 150 mm

# ACESSÓRIOS

Accesorios // Parts and accessories

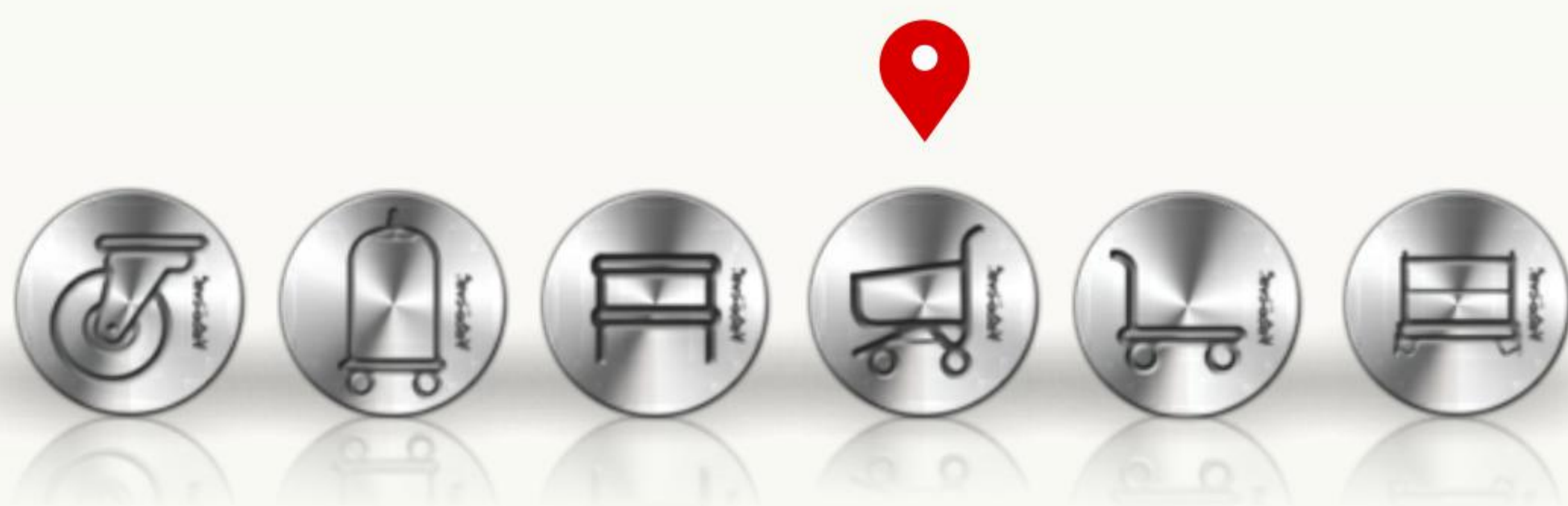

**Nossa linha de Rodas e Rodízios é compatível com qualquer modelo de carrinho.**

Nuestra linea de ruedas y rodajas es compatible con todos modelos de carritos // Our line of castors is compatible to all shopping carts

**B3 80 e 90 L**

FRISOS

CANTONEIRA PLÁSTICA

OPÇÃO PARA ESTEIRA GRR 412 AUKC

GRR 412 BPKC

OPÇÃO PARA ESTEIRA GRR 412 AUKC

ORELHA PEQ MODELO B3 E CABO PERSONALIZADO

OPCIONAL ORELHA PEQ E CABO PERSONALIZADO PLUS

ASS. PLÁSTICO PORTA BEBE P/ B3 90 L

R 412 BPKC

OPÇÃO PARA ESTEIRA GRR 412 AUKC

**B3 130 L**

FRISOS

CANTONEIRA PLÁSTICA

OPÇÃO PARA ESTEIRA GRR 412 AUKC

GRR 412 BPKC

OPÇÃO PARA ESTEIRA GRR 512 AUKC

ORELHA PEQ MODELO B3 E CABO PERSONALIZADO

OPCIONAL ORELHA PEQ E CABO PERSONALIZADO PLUS

ASS. PLÁSTICO P/ PORTA BEBE

KIT BEBE CONFORTO

R 512 BPKC

OPÇÃO PARA ESTEIRA GRR 512 AUKC

**B3 160 e 210 L**

FRISOS

CANTONEIRA PLÁSTICA

OPÇÕES PARA ESTEIRA

GRR 512 AUKC \*GRR 512 AU2KCN GRR 512 BPKC

OPÇÕES PARA ESTEIRA

ORELHA GDE MODELO B3 E CABO PERSONALIZADO

OPCIONAL ORELHA GDE E CABO PERSONALIZADO PLUS

ASS. PLÁSTICO P/ PORTA BEBE

KIT BEBE CONFORTO

R 512 BPKC \*R 512 AU2KCN R 512 AUKC



**B4 160 L**

FRISOS

CANTONEIRA PLÁSTICA

OPÇÃO PARA ESTEIRA  
GRR 412 AUKC

GRR 412 BPKC

OPRELHA PEQ  
MODELO B3 E CABO  
PERSONALIZADO

OPCIONAL  
OPRELHA PEQ E CABO  
PERSONALIZADO PLUS

ASS. PLÁSTICO  
P/ PORTA BEBE

KIT BEBE CONFORTO

R 512 BPKC

OPÇÃO PARA ESTEIRA  
GRR 512 AUKC

**B4 180 e 210 L**

FRISOS

CANTONEIRA PLÁSTICA

OPÇÕES PARA ESTEIRA

GRR 512 AUKC \*GRR 512 AU2KCN GRR 512 BPKC

OPRELHA PEQ  
MODELO B3 E CABO  
PERSONALIZADO

OPCIONAL  
OPRELHA PEQ E CABO  
PERSONALIZADO PLUS

ASS. PLÁSTICO  
P/ PORTA BEBE

KIT BEBE CONFORTO

OPÇÕES PARA ESTEIRA

R 512 BPKC \*R 512 AU2KCN R 512 AUKC

**B3 150 L**

FRISOS

CANTONEIRA PLÁSTICA

OPÇÕES PARA ESTEIRA

GRR 512 AUKC \*GRR 512 AU2KCN GRR 512 BPKC

OPRELHA GDE  
MODELO B3 E CABO  
PERSONALIZADO

OPCIONAL  
OPRELHA GDE E CABO  
PERSONALIZADO PLUS

ASS. PLÁSTICO  
P/ PORTA BEBE

KIT BEBE CONFORTO

OPÇÕES PARA ESTEIRA

R 512 BPKC \*R 512 AU2KCN R 512 AUKC

\*Devido a uma adaptação necessária para utilização dos rodízios e rodas AU2KCN, modelos já adquiridos com rodagem convencional não são compatíveis a este tipo de sistema.



**DUPLOCAR 50 L**



**DUPLOCAR 90 L**



**DUPLOCAR 120 e 160 L**





GRR 312 BP



**KIDS CAR 50 L**



ORELHA PEQ MODELO B3  
E CABO PERSONALIZADO



R 312 BP



GRR 512 BPKC



**CARRO P/ DEFICIENTE 60 L**



R 512 BPKC



FRISOS

OPÇÕES PARA ESTEIRA



GRR 512 AUKC



\*GRR 512 AU2KCN



GRR 512 BPKC



**MAXICAR 200 L**



ORELHA PADRÃO  
E CABO PERSONALIZADO



ASS. PLÁSTICO  
P/ PORTA BEBE



KIT BEBE CONFORTO

OPÇÕES PARA ESTEIRA



R 512 BPKC



\*R 512 AU2KCN



R 512 AUKC



R 816 BPL



**MACROCAR**



ORELHA PEQ MODELO B3  
E CABO PERSONALIZADO



GIR 816 BPL  
COM ESPIGA ROSQUEADA

\*Devido a uma adaptação necessária para utilização dos rodízios e rodas AU2KCN, modelos já adquiridos com rodagem convencional não são compatíveis a este tipo de sistema.

A Rod-car é fabricante de todas as peças e acessórios para carrinhos de supermercado.

A Rod-Car es Fabricante de todos los accesorios para carros de supermercado // Rod-Car manufacturer all the accessories for shopping carts.



**RODÍZIOS LR INDUSTRIAL  
RODAS SÉRIE 14 ZIG-ZAG**

Rodas série 14 (1.1/2").  
Núcleo de polipropileno tipo Zig-Zag  
e tecnologia de travamento TECNI-ROD®.  
Rolamento de rolete.  
Diâmetros disponíveis : 4", 5" e 6"



**Abastecedor Fundo Peq e Gde s/ ou c/ Etiquetador**



**Carro Bandeja com escada**



**Carro Dupla Plataforma**

DIAMÉTRO Ø	REF. RODÍZIO GIRATÓRIO	REF. RODÍZIO FIXO	REF. RODÍZIO GIRATÓRIO C/ FREIO	REF. P/ RODA AVULSA	REF. DO CARRINHO
4"	GLR 414 BZL	FLR 414 BZL	-	R 414 BZL	CARROS TARTARUGA 22A e 22B
5"	GLR 514 BZL	FLR 514 BZL	-	R 514 BZL	39-6RW
6"	GIR 614 BZL	FIR 614 BZL	-	R 614 BZL	CARRO ABASTECICAR FUNDO GRANDE
6"	GLR 614 BZL	-	GLROA 614 BZL	R 614 BZL	CARROS OVOTAINER e FORMATAINER
6"	-	FLR 614 BZL	GLROA 614 BZL	R 614 BZL	CARRO BANDEJA COM ESCADA
6"	GLR 614 BZL	FLR 614 BZL	-	R 614 BZL	CARRO ABASTECICAR ALTO, ABASTECICAR FUNDO PEQ, CARRO DUPLA PLATAFORMA, CARRO CUBACAR ZINCADO, 39A, 39-6RE



**RODÍZIOS IR  
SÉRIE 2 SUPERTRACK**

Rodas série 2 (2"). Núcleo de polipropileno  
e tecnologia de travamento TECNI-ROD®.  
Rolamento de rolete ou de esferas do tipo "SKF".  
Diâmetros disponíveis : 5", 6", 8" e 10".



**39B**



**40B**



**Carro Tela 52 G**

DIAMÉTRO Ø	REF. RODÍZIO GIRATÓRIO	REF. RODÍZIO GIRATÓRIO	REF. P/ RODA AVULSA	REF. DO CARRINHO
6"	GIR 62 BPL	GIR 62 BPL	R 62 BPL	CARROS PLATAFORMA 39B e 40B, CARRO TELA 53A
8"	GIR 82 BPL	GIR 82 BPL	R 82 BPL	CARRO TELA 52G

**RODAS FLAT - 16**



Rodas com perfil plano série 16 (1.1/2").  
Núcleo de polipropileno e tecnologia  
de travamento TECNI-ROD®. Rolamento  
de rolete ou bucha de nylon.  
Diâmetros disponíveis: 8" e 9"



**Estacicar Pequeno/Grande**



Disponíveis com  
Roda Pneumática  
Pneu 350-4



**CARRO 13**

DIAMÉTRO Ø	REF. RODA	REF. DO CARRINHO
9"	R 916 BPN	ESTACICAR GDE e PEQ, CAIXACAR, CARRO 13

CAPACIDADE	REF. DO CARRINHO	REF. RODA	REF. RODÍZIO GIRATÓRIO	OPÇÃO P/ ESTEIRA
80 Litros	B3	R 412 BPKC	GRR 412 BPKC	AUKC
90 Litros	B3	R 412 BPKC	GRR 412 BPKC	AUKC
130 Litros	B3	R 512 BPKC	GRR 412 BPKC	AUKC
150 Litros	B3 (MAXICAR)	R 512 BPKC	GRR 512 BPKC	AU2KCN ou AUKC
160 Litros	B3	R 512 BPKC	GRR 512 BPKC	AU2KCN ou AUKC
210 Litros	B3	R 512 BPKC	GRR 512 BPKC	AU2KCN ou AUKC
160 Litros	B4	R 512 BPKC	GRR 412 BPKC	AUKC
180 Litros	B4	R 512 BPKC	GRR 512 BPKC	AU2KCN ou AUKC
210 Litros	B4	R 512 BPKC	GRR 512 BPKC	AU2KCN ou AUKC
50 Litros	DUPLOCAR	R 412 BPKC	GRR 412 BPKC	AUKC
90 Litros	DUPLOCAR	R 412 BPKC	GRR 412 BPKC	AUKC
120 Litros	DUPLOCAR	R 512 BPKC	GRR 512 BPKC	AU2KCN ou AUKC
200 Litros	MAXICAR	R 512 BPKC	GRR 512 BPKC	AU2KCN ou AUKC
50 Litros	KIDS CAR	R 312 BP	GRR 312 BP	-
60 Litros	CARRO P/ DEFICIENTE	R 512 BPKC	GRR 512 BPKC	-
160 Litros	ROD KART	R 512 BPKC	GRR 512 BPKC	AU2KCN ou AUKC
-	MACROCAR	R 816 BPL	GIR 816 BPL COM ESPIGA ROSQUEADA	-

# INDUSTRIAL

Carros de transporte // Material handling carts



13 MINI



13 x 33 x 115cm  
Roda: 8"  
Carga: 150kg

13



30 x 36 x 145cm  
Roda: 9"  
Carga: 300kg

14



30 x 41 x 149cm  
Roda: 10"  
Carga: 500kg

15



23 x 41 x 145cm  
Roda: 13,5"  
Carga: 300kg

16



20 x 38 x 123cm  
Roda: 9"  
Carga: 300kg

**CARROS ARMAZÉM ZINCADOS**

Carros almacén zincado // Zink hand carts

13 MINI Z



13 x 33 x 115cm  
Roda: 8"  
Carga: 150kg

13 Z



30 x 36 x 145cm  
Roda: 9"  
Carga: 300kg

14 Z



30 x 41 x 149cm  
Roda: 10"  
Carga: 500kg

15 Z



23 x 41 x 145cm  
Roda: 13,5"  
Carga: 300kg

16 Z



20 x 38 x 123cm  
Roda: 9"  
Carga: 300kg

FOTOS MERAMENTE ILUSTRATIVAS

**CARROS TARTARUGA**

Bases con ruedas // Steel dollies

22A



60 x 40 x 15cm  
Roda: 4" Carga: 200kg

22B



60 x 40 x 15cm  
Roda: 4" Carga: 200kg

22C



100 x 60 x 20cm  
Roda: 6" Carga: 500kg

22 INOX



60 x 40 x 15cm  
Roda: 4" Carga: 200kg

22 PLÁSTICO



75 x 45 x 15cm  
Roda: 4" Carga: 200kg

26



60cm x 15cm  
Roda: 3" Carga: 150kg

**39A**

100 x 60 x 100cm  
Roda: 6"  
Carga: 300kg

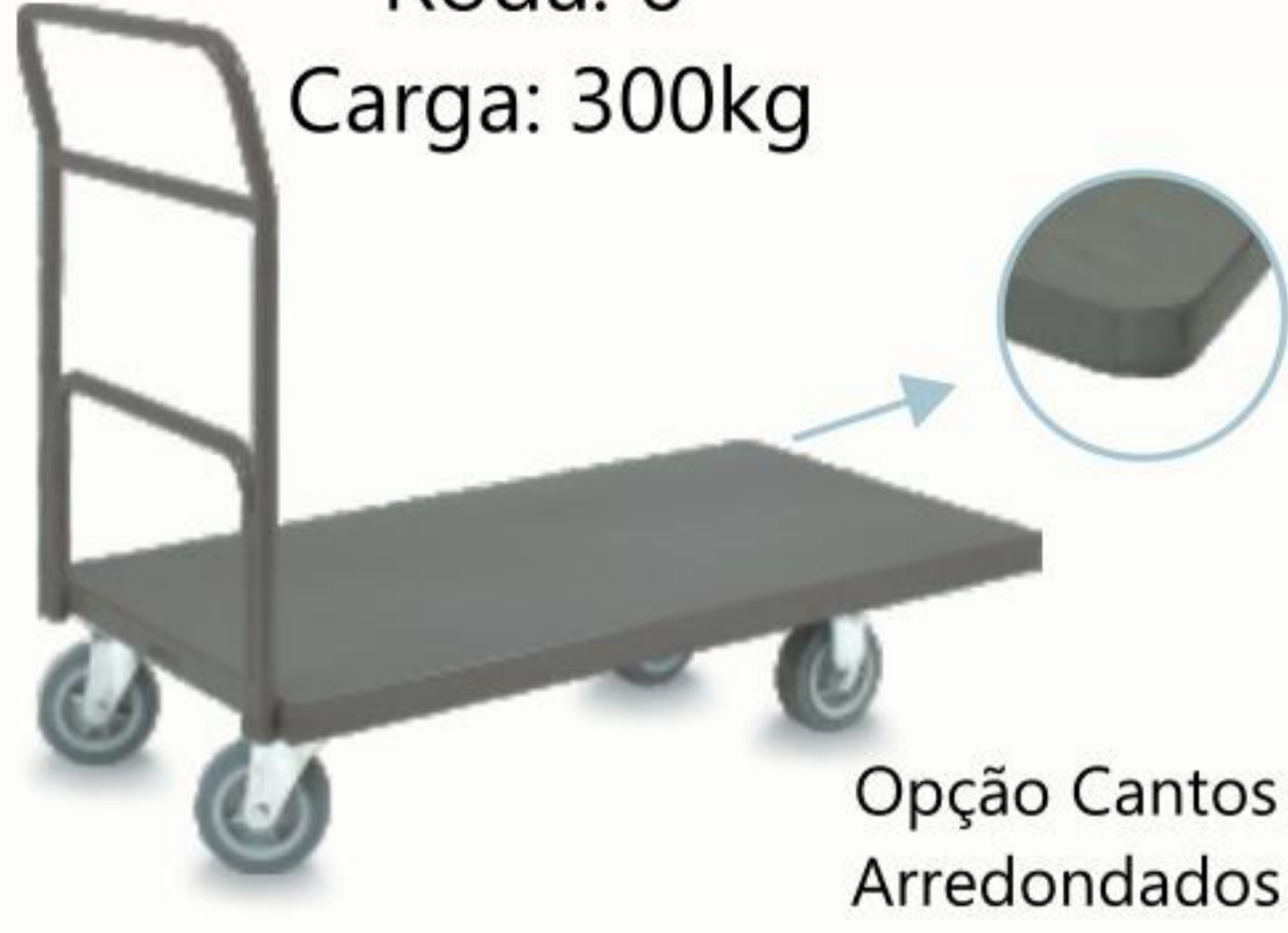

Opção Cantos Arredondados

**39B**

120 x 65 x 100cm  
Roda: 6"  
Carga: 500kg



Opção Cantos Arredondados

**39C**

150 x 80 x 100cm  
Roda: 8"  
Carga: 800kg

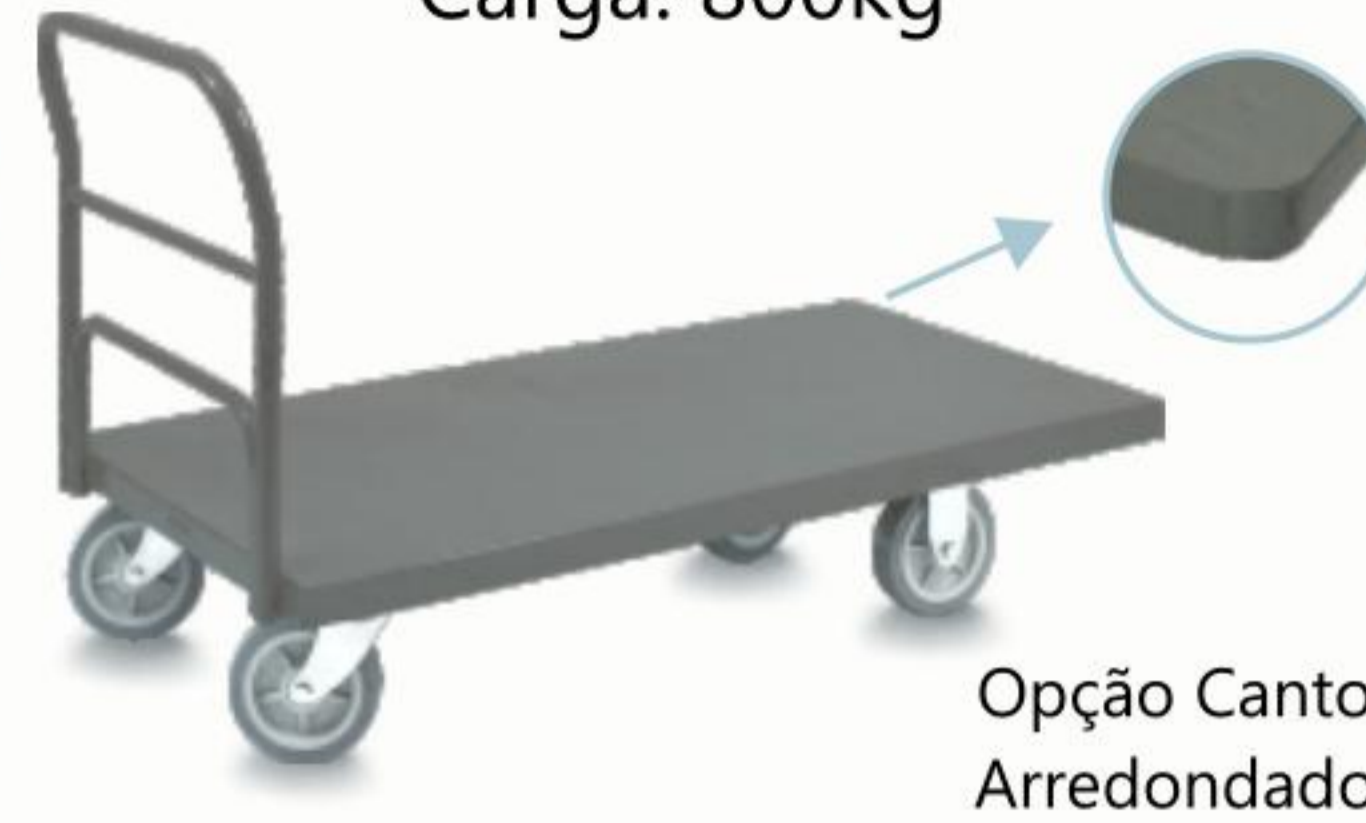

Opção Cantos Arredondados

**39D**

150 x 80 x 100cm  
Roda: 10"  
Carga: 1000kg

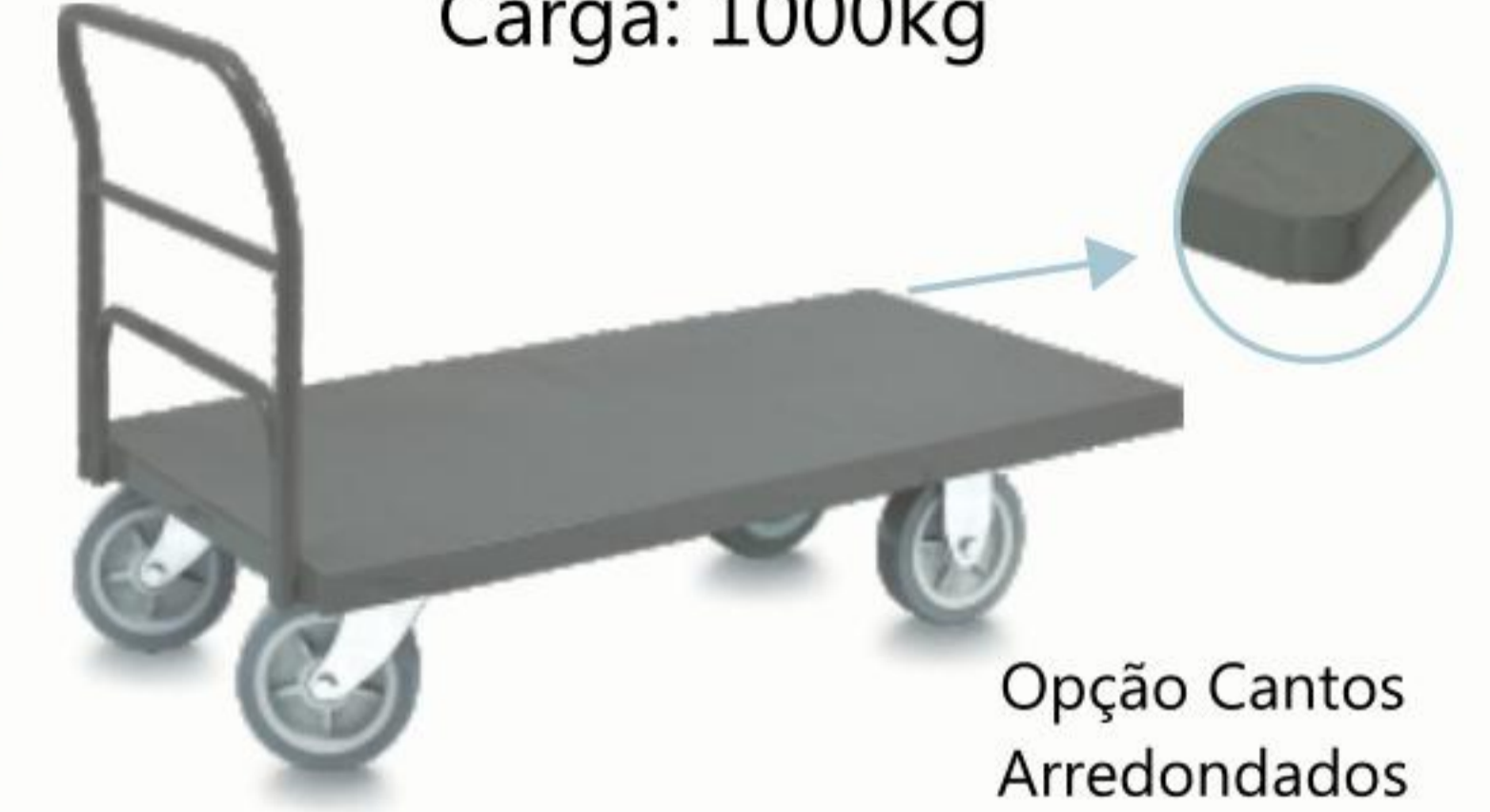

Opção Cantos Arredondados

**40A**

100 x 60 x 100cm  
Roda: 6"  
Carga: 300kg



**40B**

120 x 65 x 100cm  
Roda: 6"  
Carga: 500kg



**40C**

150 x 80 x 100cm  
Roda: 8"  
Carga: 800kg



**40D**

150 x 80 x 100cm  
Roda: 10"  
Carga: 1000kg



**41A**

100 x 60 x 100cm  
Roda: 6"  
Carga: 300kg



**41B**

120 x 65 x 100cm  
Roda: 6"  
Carga: 500kg



**41C**

150 x 80 x 100cm  
Roda: 8"  
Carga: 800kg



**41D**

150 x 80 x 100cm  
Roda: 10"  
Carga: 1000kg



**42A**

100 x 60 x 100cm  
Roda: 6"  
Carga: 300kg



**42B**

120 x 65 x 100cm  
Roda: 6"  
Carga: 500kg



**42C**

150 x 80 x 100cm  
Roda: 8"  
Carga: 800kg



**42D**

150 x 80 x 100cm  
Roda: 10"  
Carga: 1000kg



**43B**

150 x 80 x 100cm  
Roda: 10"  
Carga: 1500kg



**43E**

150 x 80 x 100cm  
Roda: 10"  
Carga: 1500kg



**39-6RE**

128 x 45 x 137cm  
Roda: 6"  
Carga: 500kg



**CARROS PNEUMÁTICOS**

Neumáticos // Wagon carts

**49A**

150 x 80 x 100cm  
Roda: 13,5"  
Carga: 800kg



**49E**

150 x 80 x 100cm  
Roda: 13,5"  
Carga: 800kg



**50A**

150 x 80 x 100cm  
Roda: 13,5"  
Carga: 800kg



**50E**

150 x 80 x 100cm  
Roda: 13,5"  
Carga: 800kg



**51A**

150 x 80 x 100cm  
Roda: 13,5"  
Carga: 800kg



**51E**

150 x 80 x 100cm  
Roda: 13,5"  
Carga: 800kg



**52A**

150 x 80 x 100cm  
Roda: 13,5"  
Carga: 800kg



**52E**

150 x 80 x 100cm  
Roda: 13,5"  
Carga: 800kg



**52B**

150 x 80 x 100cm  
Roda: 13,5"  
Carga: 800kg



**52F**

150 x 80 x 100cm  
Roda: 13,5"  
Carga: 800kg



**58A - 2 m**

Roda: 4" com freio  
7 degraus  
125 x 80 x 200cm

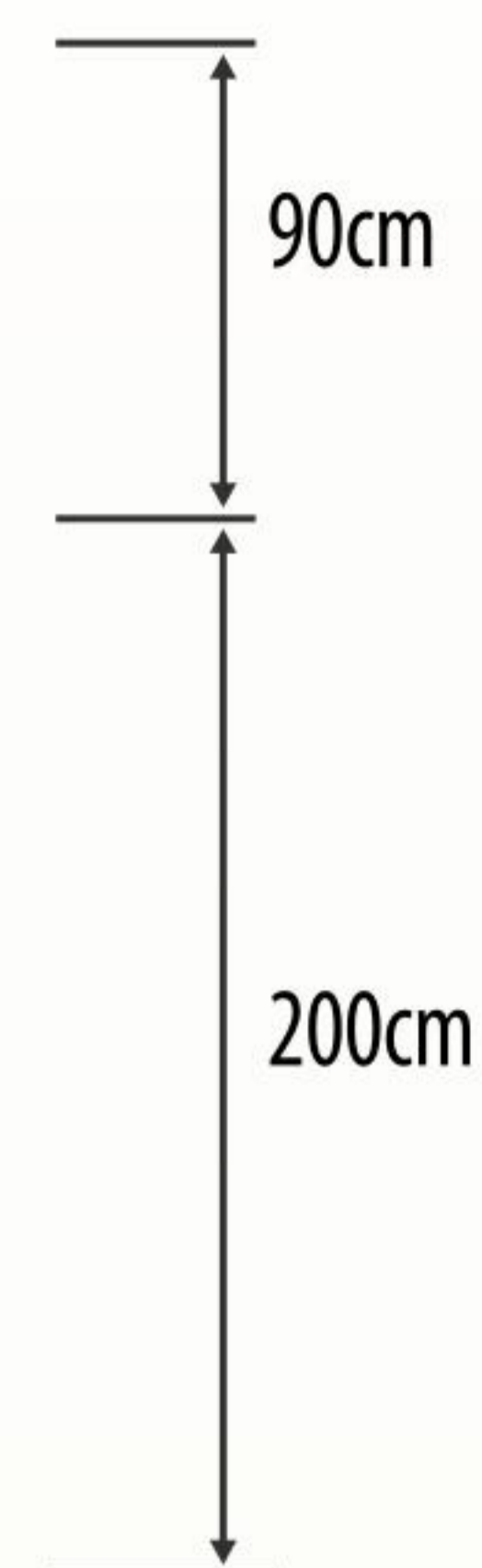

**58B - 2,5m**

Roda: 4" com freio  
9 degraus  
Trava sapata  
200 x 87 x 250cm



**58C - 3m**

Roda: 4" com freio  
10 degraus  
Trava sapata  
200 x 87 x 300cm



Degraus em Chapa Xadrez

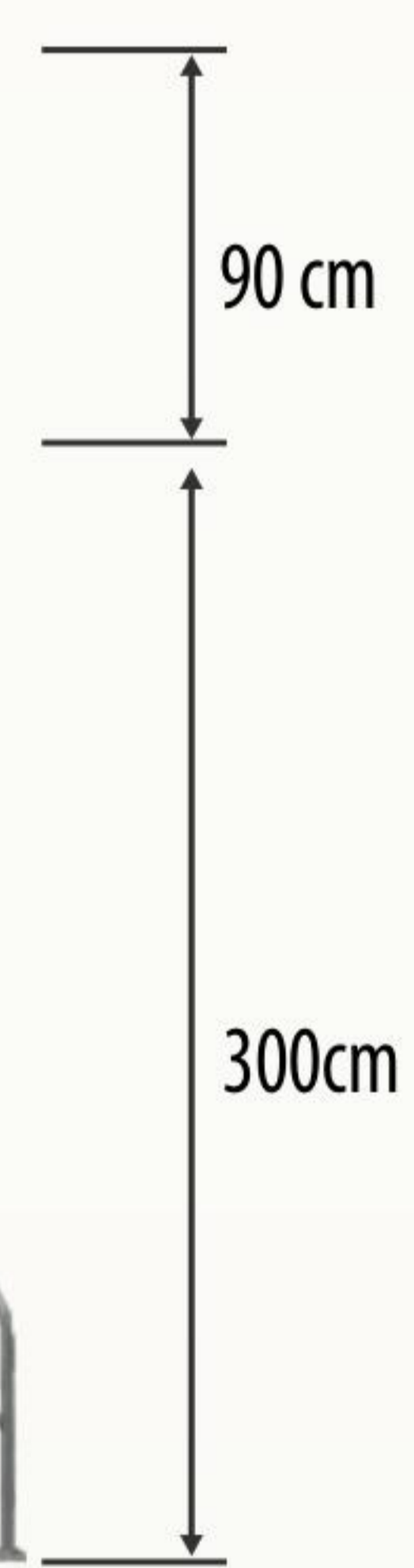

**58D - 1,5m**

Roda: 4" com freio  
5 degraus  
123 x 76 x 150cm

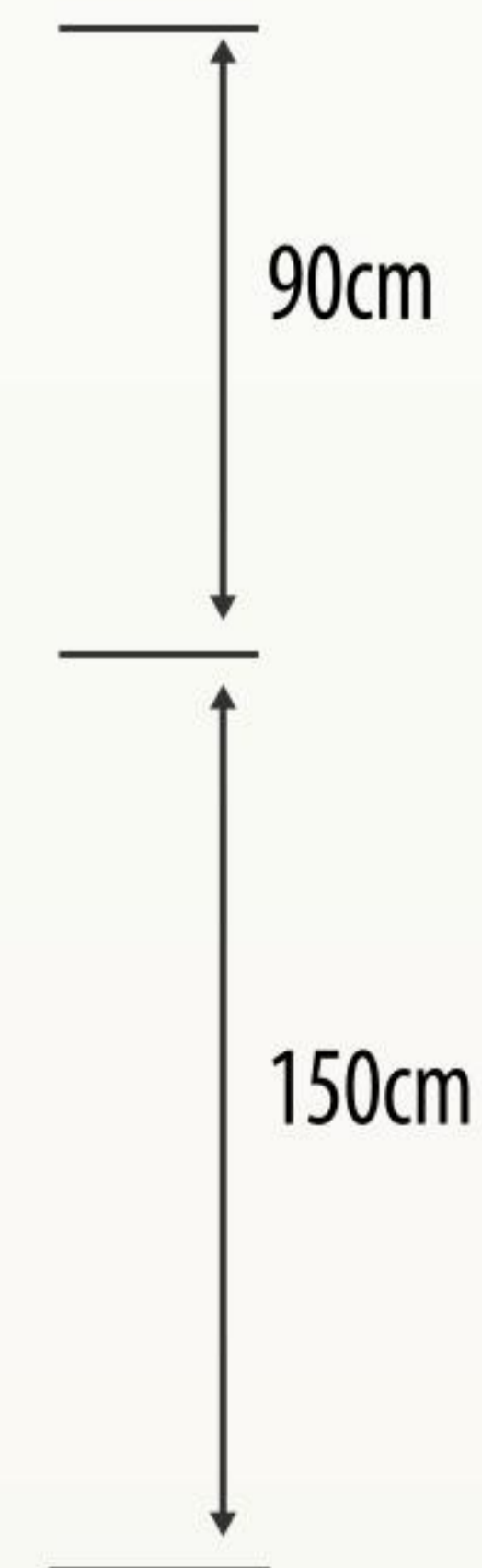



53A



120 x 70 x 90cm  
Roda: 6" Carga: 500kg

53B



120 x 70 x 95cm  
Roda: 8" Carga: 800kg

53E



120 x 70 x 90cm  
Roda: 6" Carga: 500kg

53F



120 x 70 x 95cm  
Roda: 8" Carga: 800kg

54A



120 x 70 x 115cm  
Roda: 6" Carga: 500kg

54B



120 x 70 x 120cm  
Roda: 8" Carga: 800kg

54E



120 x 70 x 115cm  
Roda: 6" Carga: 500kg

54F



120 x 70 x 120cm  
Roda: 8" Carga: 800kg

52G



195 x 98 x 160cm  
Roda: 8" Carga: 800kg

**CARRO TAMBOR**

Carro tambor // Drum cart

29

Largura: 40cm  
Altura: 160cm  
Roda: 10"  
Capacidade: 300kg



**CARRO LIXEIRA**

Carro para basura // Trash cart

L1

165 x 40cm  
Roda: 6"  
Capacidade: 80Lts



**CARRO BANDEJA**

Carro bandeja // Utility cart

47 II



98 x 58 x 95cm  
Roda: 4" Carga: 300kg

47 III



98 x 58 x 95cm  
Roda: 4" Carga: 300kg

**ENTORNADOR DE TAMBOR**

Manipulador de tambor // Drum movers

32S

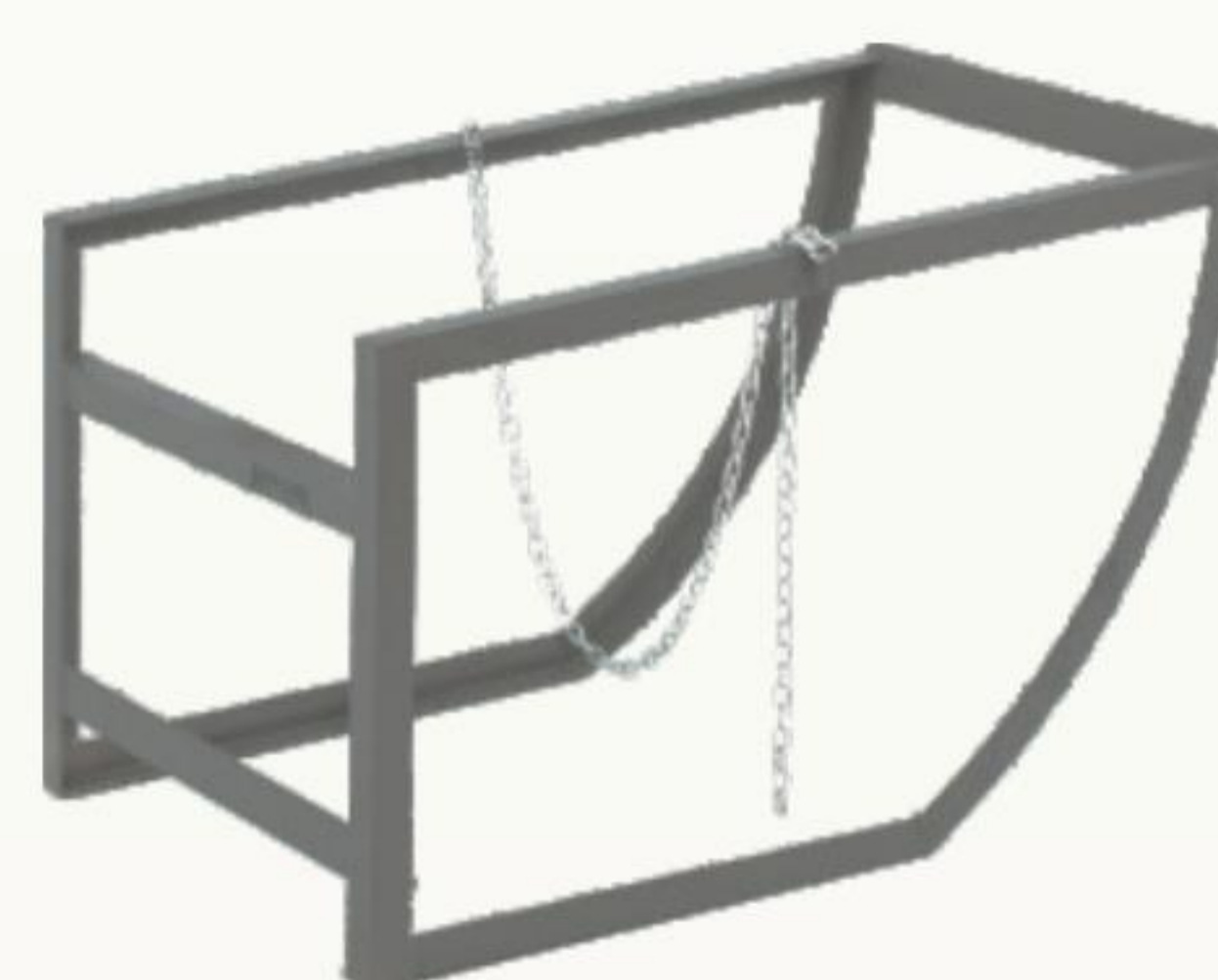

80 x 50 x 55cm  
Carga: 200kg

32C



80 x 50 x 60cm  
Roda: 3" Carga: 200kg

# ARMAZENAGEM

Almacén // Storage



A linha Stock Tainer Rod-Car dispensa o uso de pallet de madeira e seu empilhamento (4 sobre 1) pode ser, tanto montado como desmontado. Facilita o acesso ao produto e permite uma visualização completa do material.



**STL-T**  
Empilhamento montado



**STL-T**  
Montado



**STL-T**  
Empilhamento desmontado

MODELO	EXTERNA	INTERNA	CARGA	MALHA	TARA
STL-T 001.3.03	850x730x730	780x690x610	300	100x50	20
STL-T 002.3.05	1240x660x700	1170x630x580	300	110x50	27
STL-T 003.4.06	1070x830x830	1000x800x700	400	110x60	29
STL-T 004.4.06	1260x940x960	1200x900x830	400	110x60	37

## Linha - STM (Médio)

Contenedores alambrados mediano // Medium duty wire containers



**STM-T**

MODELO	EXTERNA	INTERNA	CARGA	MALHA	TARA
STM-T 011.6.06	960x800x970	870x770x750	600	110x60	41

## Linha - STP (Pesado)

Contenedores alambrados pesado // Heavy duty wire containers



**STP-T**

MODELO	EXTERNA	INTERNA	CARGA	MALHA	TARA
STP-T 021.7.06	1280x1080x980	1200x1000x850	700	110x60	61
STP-T 023.6.06	1230x850x940	1150x770x810	600	110x60	52

## SUGESTÕES



Colmeia em polionda para Separação de Produtos

### Proteção para peças pequenas ou sensíveis

Protección para productos pequeños y delicados

Plastic divider

Opção de cores para polionda



Revestimento Total em Polionda



**STE-C 032.5.22**



**STE-C (Empilhamento desmontado)**



**STE-C (Chapa)**



**STE-M (Madeira)**



**STE-T (Tela)**

MODELO (tela)	MODELO (madeira)	MODELO (chapa)	EXTERNA	INTERNA	CARGA	MALHA	TARA
STE-T 032.5.22	STE-M 032.5.22	STE-C 032.5.22	840x550x560	760x470x400	500	33x33	23
STE-T 024.5.11	STE-M 024.5.11	STE-C 024.5.11	1220x825x950	1170x750x780	500	125x60	55
STE-T 025.6.11	STE-M 025.6.11	STE-C 025.6.11	1220x825x1150	1170x750x980	600	125x60	61
STE-T 027.5.11	STE-M 027.5.11	STE-C 027.5.11	1025x1220x950	950x1170x780	500	125x60	65

Linha - STA (Alto)  
High wire containers



**STA-C**

(STA-C 018.8.04 e STA-C 019.9.04)



**STA-C 115.4.37**



**STA-T 064.4.29**

MODELO	EXTERNA	INTERNA	CARGA	MALHA	TARA
STA-C 018.8.04	1230x830x1600	1130x750x1440	800	100x80	66
STA-C 019.9.04	1230x830x1850	1130x750x1690	900	100x80	72
STA-C 115.4.37	1200x1000x1200	1125x950x1045	400	100x60	69
STA-T 064.4.29	1075x1145x1100	1000x1070x940	400	50x30	64

## Linha - STR (Com rodas)

Contenedores alambrados con ruedas // Wire containers with casters



Os containers STR já estão preparados para encarrilhamento. Possuem 2 rodízios giratórios e 2 fixos além de engate frontal. Seu empilhamento é de 2 sobre 1, tanto montado quanto desmontado.



Engate



STR-T 030.4.07 / STR-T 031.5.07



Desmontado

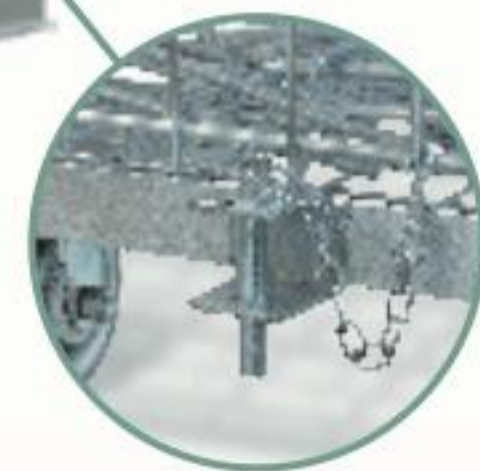

Travamento

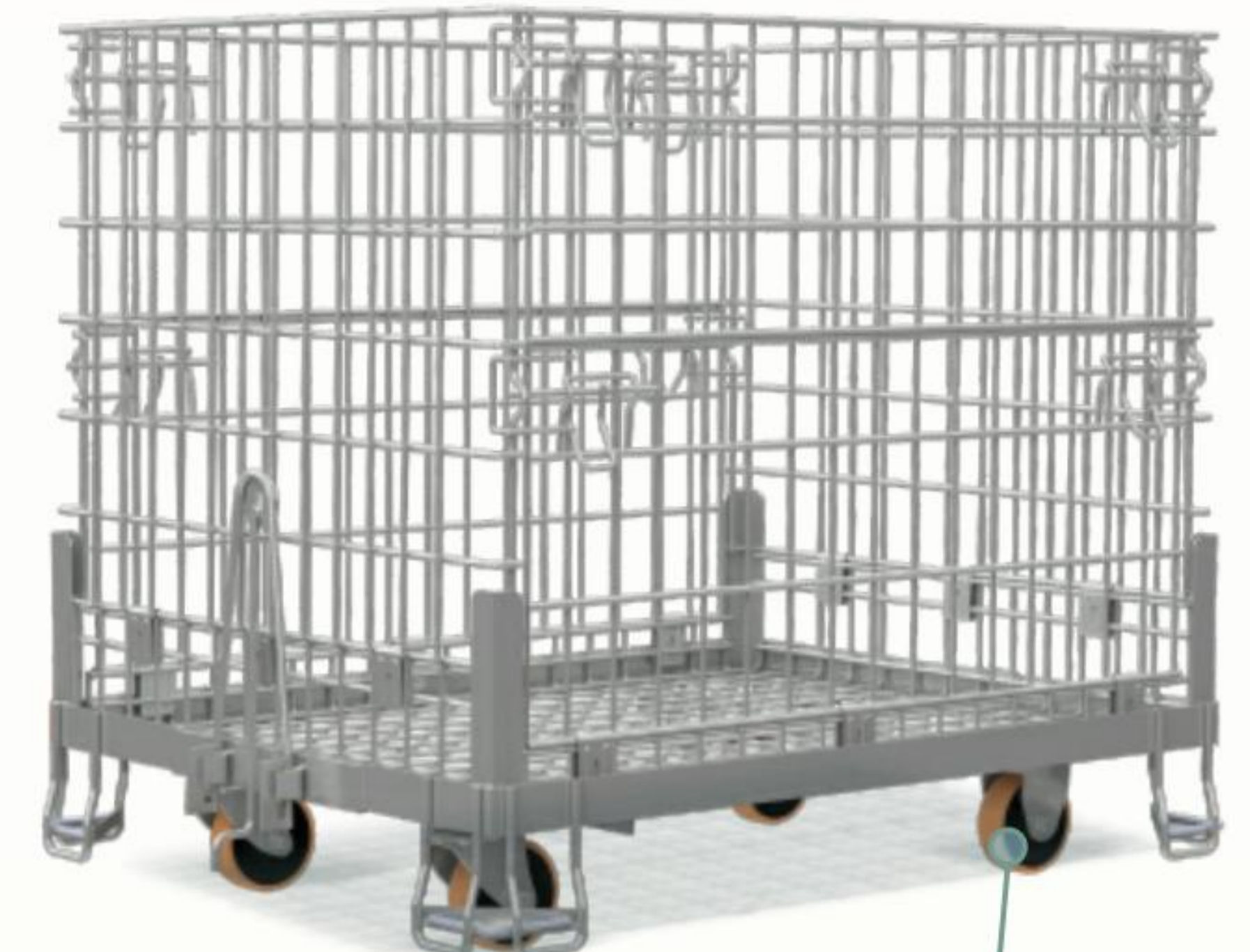

STR-T 302.4.78  
Ideal para indústria automotiva



Roda com núcleo de ferro e revestimento em poliuretano

MODELO	EXTERNA	INTERNA	CARGA	MALHA	TARA
STR-T 030.4.07	1150x850x1150	1080x780x950	400	113x60	62
STR-T 031.5.07	1700x1150x1150	1630x1070x950	500	113x60	87
STR-T 302.4.78	1285x1080x1095	1200x1000x900	400	60x120	92

## Linha - STF (Aço) e STI (Inox)

Acero carbono y inoxidable // Stainless steel and steel rigid containers



MODELO	EXTERNA	INTERNA	CARGA	MALHA	TARA
STF-C 020.5.10	1230x830x950	1140x775x800	500	120x73	51
STF-C 022.6.10	1230x830x1150	1140x775x1000	600	120x73	60
STI-C 020.5.10	1230x830x950	1140x775x800	500	120x73	51
STI-C 022.6.10	1230x830x1150	1140x775x1000	600	120x73	60

## Linha - CAIXA KAN-BAN

Contenedor para separación // Bulk containers

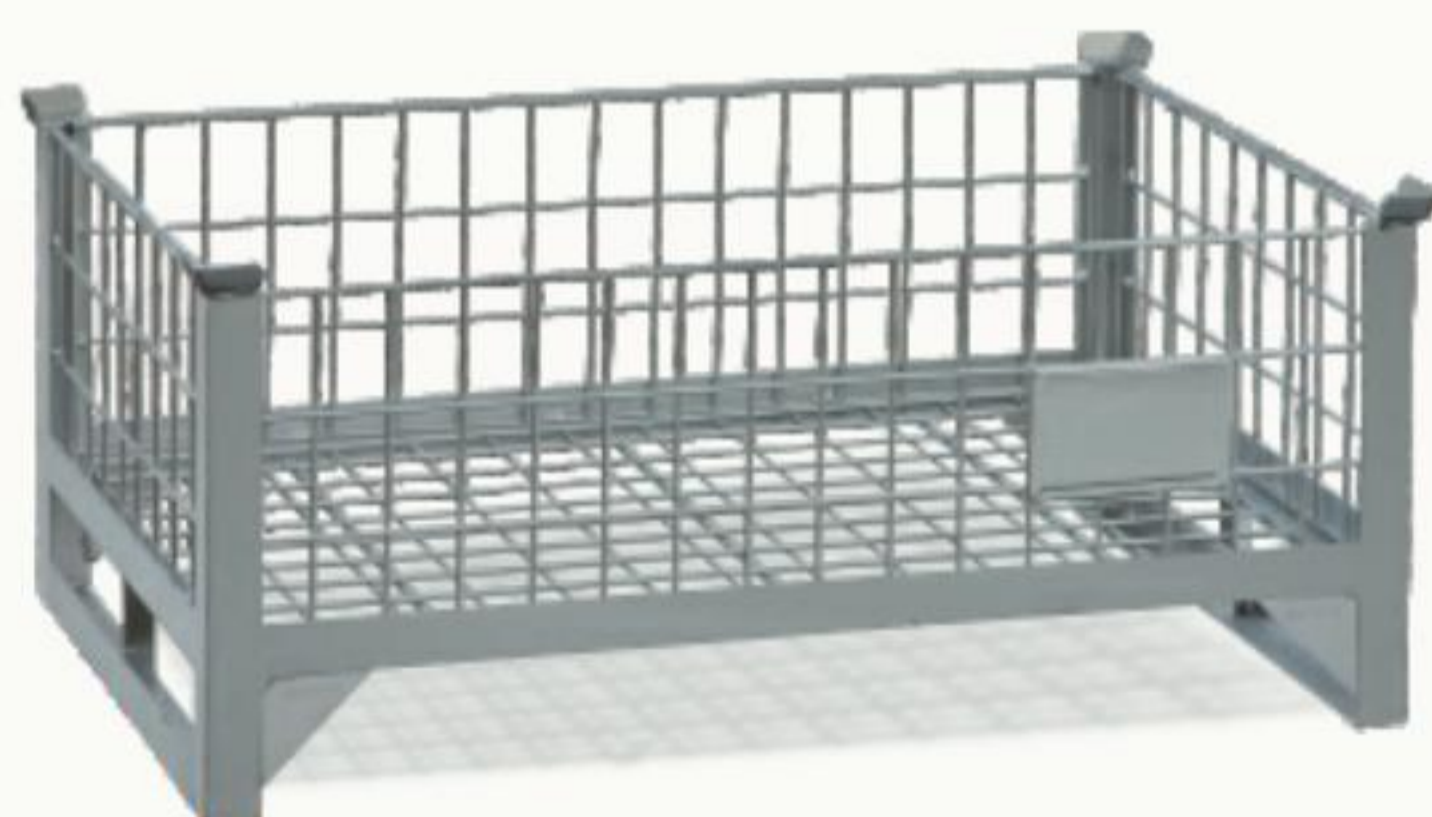

MODELO	EXTERNA	INTERNA	CARGA	MALHA	TARA
CK-T 028.3.02	900x600x375	830x530x265	300	85x50	18
CK-T 029.3.03	1000x700x500	935x635x300	300	100x50	25

## Linha - ROLL CONTAINER

Carros para transporte con seguridad y confinados // Security cart

São carros aramados ideais para transporte de mercadorias. Possuem bandeja divisória, sistema de freio nas rodas traseiras, portas e dispositivo para tracionamento. São dobráveis e encaixáveis.

MODELO	EXTERNA	INTERNA	CARGA	MALHA	TARA
RC 183.5.37	800x975x2000	750x930x1715	500	100x60	89
RC 202.3.52	750x1000x1860	700x930x1570	300	100x55	82



Medidas: comprimento x largura x altura (mm)

Medidas: Largo x Ancho x Alto (mm) // Measurements: length x width x height (mm)

Laterais aramadas para pallets de madeira. Empilhamento de até 4 sobre 1, abertura frontal de 2 níveis, fácil montagem e desmontagem.



Obs.: As laterais aramadas não acompanham pallets de madeira.

**PS 121.4.26**

**PS 006**

**PS 079**

**PS 104**

**PS 010**

**Desmontado**

Montado sobre base metálica com fundo de madeira

\*Base vendida separadamente



**Base para PS - Tara: 34kg**

Medidas externa: 1200x1000x240mm

MODELO	EXTERNA	INTERNA	CARGA	MALHA	TARA
PS 010.7.20	1200x1000x1000	1160x960x1000	700	160x70	32
PS 006.7.15	1200x1000x1500	1160x960x1500	700	145x70	49
PS 104.0.15	1200x1200x1000	1160x1160x1000	1000	145x70	43
PS 079.7.15	1200x1200x1500	1160x1160x1500	700	145x70	56
PS 121.4.26	1200x1000x1750	1160x960x1750	400	140x140	49

## PALLET RACK



MODELO	EXTERNA	INTERNA	QNT. TRAVESSAS
PR 478.7.00/325	1280x1080x1120	1200x1000x930	8
PR 474.7.00/326	1280x1080x1320	1200x1000x1130	12
PR 475.7.00/326	1280x1080x1520	1200x1000x1330	12
PR 476.7.00/327	1280x1080x1620	1200x1000x1430	16
PR 477.7.00/327	1280x1080x2020	1200x1000x1830	16

Obs.: Não acompanham pallets de madeira.

## CARRO PARA PICKING

Carros para separación de productos // Picking cart



Med.: 990x650x1720mm

Medidas: comprimento x largura x altura (mm)

Medidas: Largo x Ancho x Alto (mm) // Measurements: length x width x height (mm)

Soluções sob medida para as mais diversas necessidades.  
Disponemos de uma equipe técnica especializada para projetos tridimensionais e prototipagem.



Rack para transporte de capa da lanterna interna traseira



Rack para capô



Rack para transporte de cockpit



Rack para transporte de bagageiro do teto



Rack para transporte de capa da lanterna



Rack para transporte de capa de alojamento do amortecedor



Rack para transporte de motos



Caixa metálica dobrável

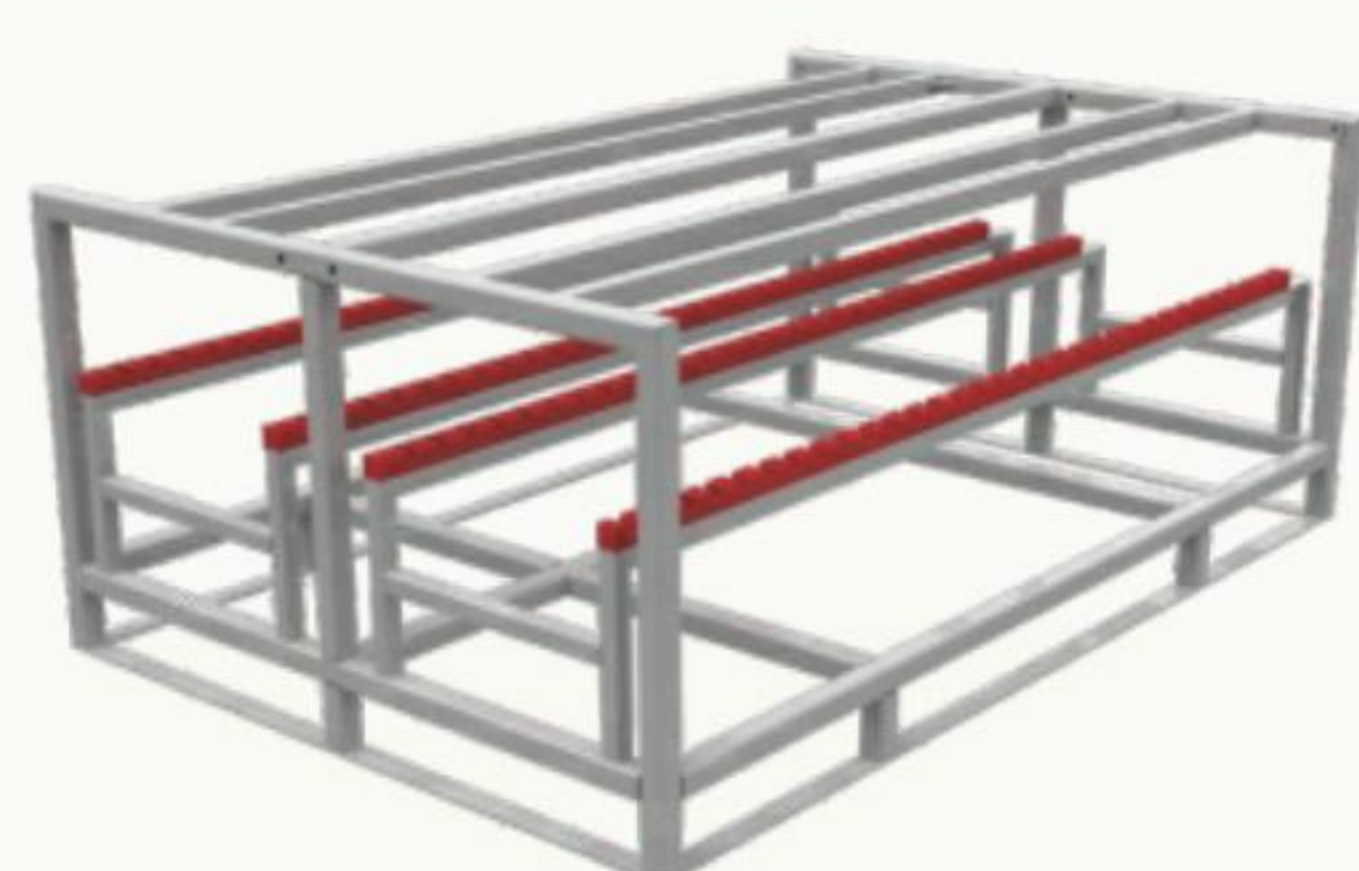

Rack para transporte de estribos



Rack para transporte da coluna T



Carro dolly para rack



Rack para armazenamento de volante

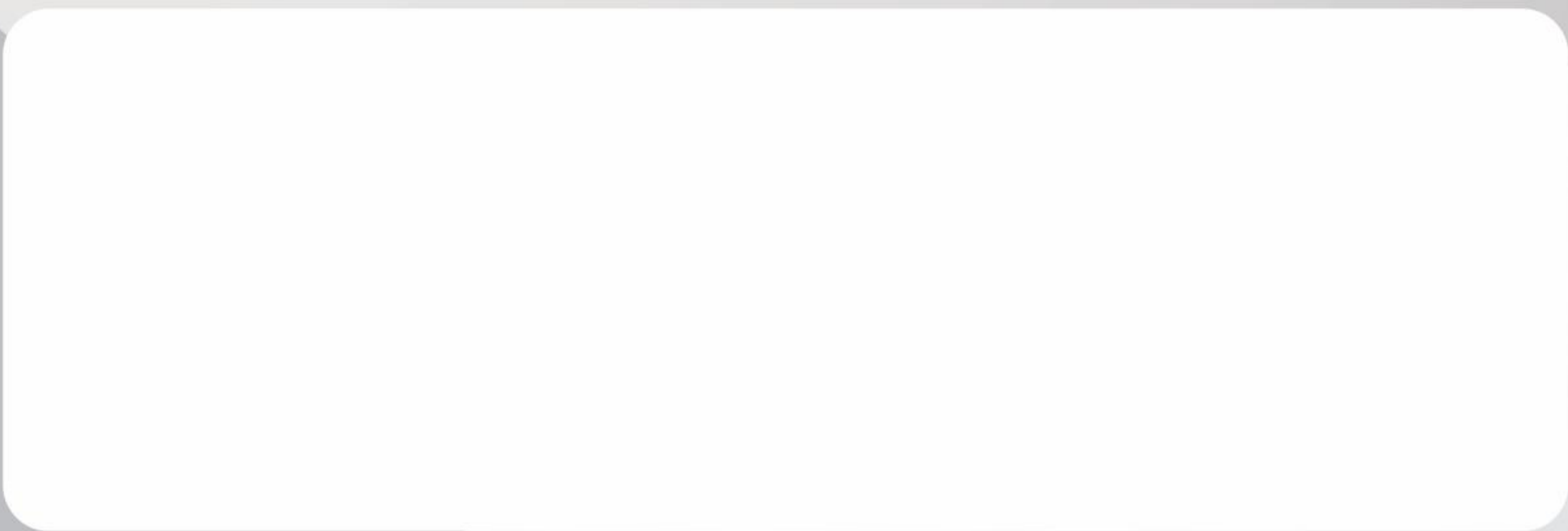

Rua Silvio Manfredi, 214 - Guarulhos - SP CEP 07241-000  
Tel.: (11) 2145-8500

**[www.rodcar.com.br](http://www.rodcar.com.br)**



Acesse o QR Code para  
mais informações